

# Busbars and distribution

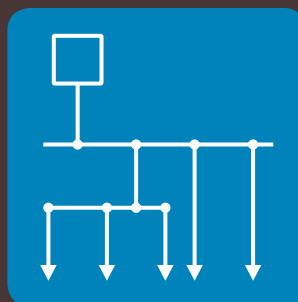

12

POWER GUIDE 2009 / **BOOK 12**

# INTRO

**Protection and control of operating circuits are the basic functions of a distribution panel. But upstream there is another function, possibly more discreet, but just as essential: distribution.**

Even more than for the protection and control functions, the selection and setup of distribution equipment require an approach that combines selection of products (number of outputs, cross-sections, conductor types, connection method) and checking the operating conditions (current-carrying capacity, short circuits, isolation, etc.) in multiple configurations.

Depending on the power installed, distribution is carried out via distribution blocks (up to 400 A) or via busbars (250 A to 4000 A). The former must be selected according to their characteristics (see page 32), while the latter must be carefully calculated and sized according to requirements (see page 06).

In accordance with its policy of continuous improvement, the Company reserves the right to change specifications and designs without notice. All illustrations, descriptions, dimensions and weights in this catalogue are for guidance and cannot be held binding on the Company.

<b>Distribution and standards</b> .....	<b>02</b>
Statutory conditions for the protection of branch or distributed lines .....	04
<b>Sizing busbars</b> .....	<b>06</b>
Determining the usable cross-section of the bars .....	06
Checking the permissible thermal stress .....	12
Determining the distances between supports .....	13
Magnetic effects associated with busbars .....	20
Checking the insulation characteristics .....	23
<b>Shaping and connecting bars</b> .....	<b>26</b>
Rigid bars .....	26
Flexible bars .....	30
Current transformers (CT) .....	31
<b>Distribution blocks</b> .....	<b>32</b>
Characteristics of distribution blocks .....	33
Phase balancing .....	36
Legrand distribution blocks .....	40
<b>Choice of products</b> .....	<b>46</b>

# Distribution and standards

Distribution can be defined as supplying power to a number of physically separate and individually protected circuits from a single circuit.

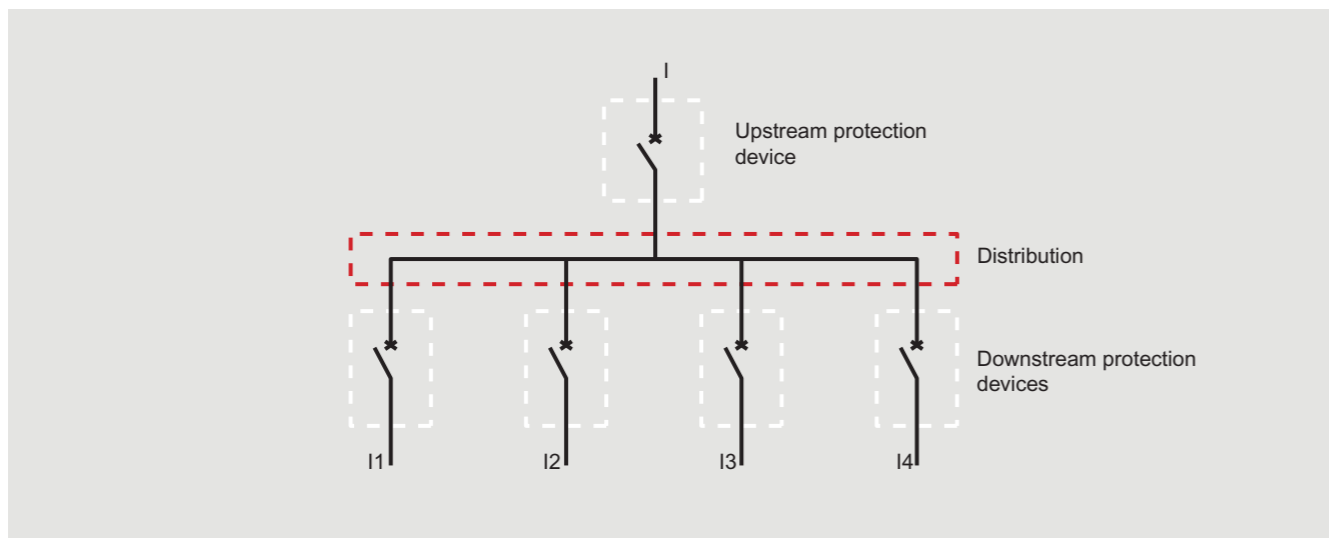

Depending on the circuits to be supplied, distribution will be via busbars (flat or C-section copper or aluminium bars, see p. 06), via prefabricated distribution blocks (power distribution blocks, modular distribution blocks, distribution terminal blocks, see p. 32) or via simple supply busbars. According to the standards, a device providing protection against short circuits and overloads must be placed at the point where a change of cross-section, type, installation method or composition leads to a reduction in the current-carrying capacity (IEC 60364-4-43).



^ Branch busbar in cable sleeve: C-section aluminium bars



^ Main busbar at the top of the enclosure with 2 copper bars per pole

If it were applied to the letter, this rule would lead to over-sizing of cross-sections for fault conditions. The standard therefore allows for there to be no protection device at the origin of the branch line subject to two conditions.

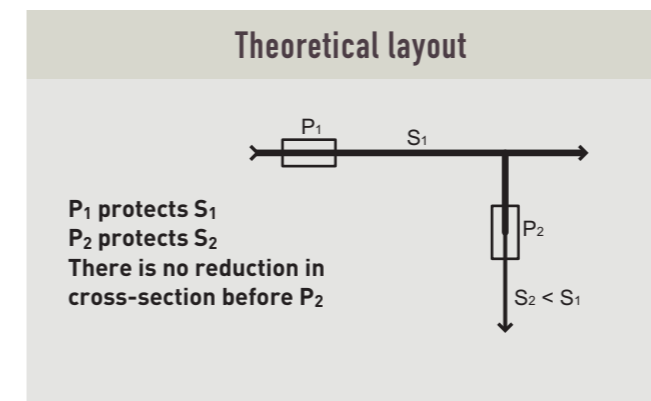

Upstream device P1 effectively protects the branch line S2 ...

... or the branch line S2 is less than three metres long, is not installed near any combustible materials and every precaution has been taken to limit the risks of short circuits. There is no other tap-off or power socket on the branch line S2 upstream of protection P2.

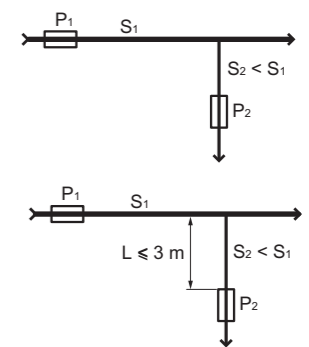

## Multi-level distribution

This layout can be used for example when several distribution blocks (2<sup>nd</sup> level) are supplied from a single busbar (1<sup>st</sup> level). If the sum of the currents tapped off at the first level (I<sub>1</sub>, I<sub>2</sub>, etc.) is greater than I<sub>t</sub>, a protection device P<sub>2</sub> must be provided on S<sub>2</sub>.

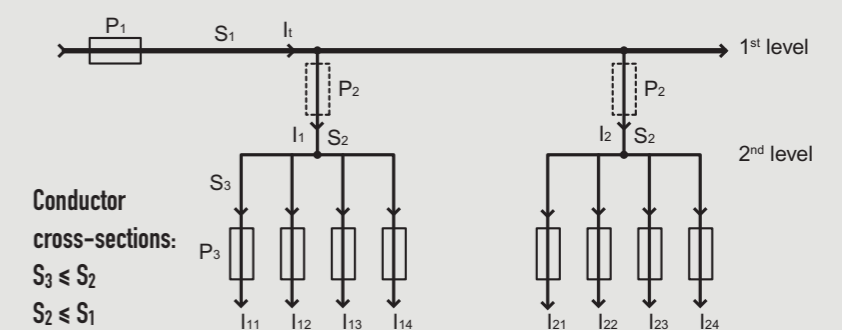

< Modular distribution block



^ Distribution via supply busbars



# Distribution and standards (continued)

## STATUTORY CONDITIONS FOR PROTECTING BRANCH OR DISTRIBUTED LINES

### 1 SUMMARY OF THE GENERAL PRINCIPLE FOR CHECKING THERMAL STRESS

For insulated cables and conductors, the breaking time of any current resulting from a short circuit occurring at any point must not be longer than the time taken for the temperature of the conductors to reach their permissible limit. This condition can be verified by checking that the thermal stress  $K^2S^2$  that the conductor can withstand is greater than the thermal stress (energy  $I^2t$ ) that the protection device allows to pass.

### 2 CHECKING THE PROTECTION CONDITIONS OF THE BRANCH LINE(S) WITH REGARD TO THE THERMAL STRESSES

For branch lines with smaller cross-sections ( $S_2 < S_1$ ), check that the stress permitted by the branch line is actually greater than the energy limited by the main device  $P_1$ . The permissible thermal stress values  $K^2S^2$  can be easily calculated using the k values given in the table below:

The maximum energy values limited by the devices are given in the form of figures (for example 55,000 A<sup>2</sup>s for modular devices with ratings up to 32 A or in the form of limitation curves (see Book 5).

### 3 CHECKING THE PROTECTION CONDITIONS USING THE "TRIANGLE RULE"

The short-circuit protection device  $P_1$  placed at the origin A of the line can be considered to effectively protect branch  $S_2$  as long as the length of the branch busbar system  $S_2$  does not exceed a certain length, which can be calculated using the triangle rule.

- The maximum length  $L_1$  of the conductor with cross-section  $S_1$  corresponds to the portion of the circuit AB that is protected against short circuits by protection device  $P_1$  placed at point A.
- The maximum length  $L_2$  of the conductor with cross-section  $S_2$  corresponds to the portion of the circuit AM that is protected against short circuits by protection device  $P_1$  placed at point A.

These maximum lengths correspond to the minimum short circuit for which protection device  $P_1$  can operate (see Book 4).

K values for conductors

Property/Condition	Type of insulation of the conductor							
	PVC Thermoplastic		PVC Thermoplastic 90°C		EPR XLPE Thermosetting	Rubber 60°C Thermosetting	Mineral	
Conductor cross-sect. mm <sup>2</sup>	≤ 300	> 300	≤ 300	> 300				
Initial temperature °C	70		90		90	60	70	105
Final temperature °C	160	140	160	140	250	200	160	250
K values								
Copper conductor	115	103	100	86	143	141	115	135-115
Aluminium conductor	76	68	66	57	94	93	-	-
Connections soldered with tin solder for copper conductors	115	-	-	-	-	-	-	-

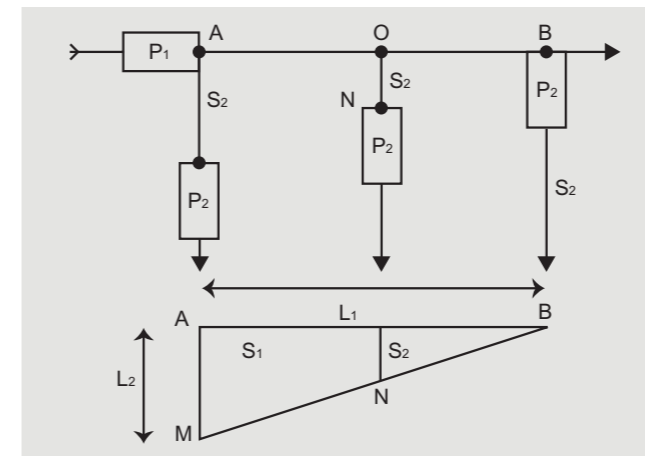

$S_1$  corresponds to the cross-section of the main conductor and  $S_2$  to the cross-section of the branch conductor.

The maximum length of the branch conductor with cross-section  $S_2$  that is protected against short circuits by protection device  $P_1$  placed at point A is represented by segment ON. It can be seen using this representation that the protected length of the branch line decreases the further away the tap-off point is from protection  $P_1$ , up to the prohibition of any  $S_2$  smaller cross-section tap-off at the apex of the triangle, B.

This method can be applied to short-circuit protection devices and those providing protection against overloads respectively, as long as device  $P_2$  effectively protects line  $S_2$  and there is no other tap-off between points A and O.

### 4 3 METRE RULE APPLIED TO OVERLOAD PROTECTION DEVICES

When protection device  $P_1$  placed at the head of line  $S_1$  does not have any overload protection function or its characteristics are not compatible with the overload protection of the branch line  $S_2$  (very long circuits, significant reduction in cross-section), it is possible to move device  $P_2$  up to 3 m from the origin (O) of the tap-off as long as there is no tap-off or power socket on this portion of busbar system and the risk of short circuit, fire and injury is reduced to the minimum for this portion (use of reinforced insulation conductors, sheathing, separation from hot and damaging parts).

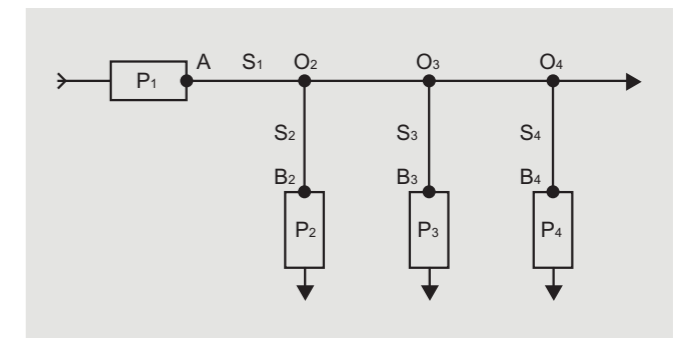
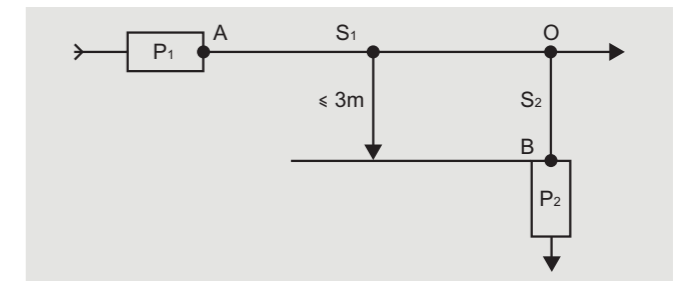

### 5 EXEMPTION FROM PROTECTION AGAINST OVERLOADS

The diagram above illustrates three examples of tap-offs ( $S_1, S_2, S_3$ ) where it is possible not to provide any overload protection or simply not to check whether this condition is met.

- Busbar system  $S_2$  is effectively protected against overloads by  $P_1$  and the busbar system does not have any tap-offs or power sockets upstream of  $P_2$
- Busbar system  $S_3$  is not likely to have overload currents travelling over it and the busbar system does not have any tap-offs or power sockets upstream of  $P_3$
- Busbar system  $S_4$  is intended for communication, control, signalling and similar type functions and the busbar system does not have any tap-offs or power sockets upstream of  $P_4$ .

# Sizing busbars

The busbar constitutes the real “backbone” of any distribution assembly. The main busbar and branch busbars supply and distribute the energy.

Busbars can be created using copper or aluminium bars. Flat copper bars are used for busbars up to 4000 A with Legrand supports. They provide great flexibility of use, but require machining on request (see p. 26). Legrand aluminium bars are made of C-section rails. Connection is carried out without drilling, using special hammer head screws.

They are used for busbars up to 1600 A, or 3200 A by doubling the supports and the bars. The electrical and mechanical characteristics of Legrand busbar supports, and strict compliance with the maximum installation distances, ensure isolation between the poles and that the bars can resist the electrodynamic forces.

## DETERMINING THE USABLE CROSS-SECTION OF THE BARS

The required cross-section of the bars is determined according to the operating current, the protection index of the enclosure and after checking the short-circuit thermal stress.

The currents are named in accordance with the definitions in standard IEC 60947-1 applied to the usual operating conditions for a temperature rise  $\Delta t$  of the bars which does not exceed 65°C.



### Currents according to standard IEC 60947-1

- **I<sub>e</sub>**: rated operating current to be taken into consideration in enclosures with natural ventilation or in panels with IP ≤ 30 protection index (ambient internal temperature ≤ 25°C).
- **I<sub>the</sub>**: thermal current in enclosure corresponding to the most severe installation conditions. Sealed enclosures do not allow natural air change, as the IP protection index is greater than 30 (ambient internal temperature ≤ 50°C).



### Parallel bars

The current-carrying capacity in *n* bars is less than *n* times the current-carrying capacity in one bar. Use *n* = 1.6 to 1.8 for a group of 2 bars, *n* = 2.2 to 2.4 for 3 bars and *n* = 2.7 to 2.9 for 4 bars. The wider the bars, the more coefficient *n* is affected, the more difficult they are to cool and the higher the mutual inductance effects. The permissible current density is not therefore constant: it is approximately 3 A/mm<sup>2</sup> for small bars and falls to 1 A/mm<sup>2</sup> for groups of large bars.



< Temperature rise test for a 3 x 120 x 10 per pole busbar on support Cat. No. 374 54

## 1 C-SECTION ALUMINIUM BARS (supports Cat. Nos. 373 66/67/68/69)



< Supports Cat. Nos. 373 66/67: with aligned bars



< Supports Cat. Nos. 373 68/69: with stepped bars

C-section aluminium bars					
I <sub>e</sub> (A) IP ≤ 30	I <sub>the</sub> (A) IP > 30	Cat. No.	Cross-section (mm <sup>2</sup> )	I <sup>2</sup> t (A <sup>2</sup> s)	I <sub>cw1s</sub> (A)
800	630	1 x 373 54	524	2.2 x 10 <sup>9</sup>	46,900
1000	800	1 x 373 55	549	2.5 x 10 <sup>9</sup>	49,960
1250	1000	1 x 373 56	586	2.8 x 10 <sup>9</sup>	53,325
1450	1250	1 x 373 57	686	3.9 x 10 <sup>9</sup>	62,425
1750	1600	1 x 373 58	824	5.6 x 10 <sup>9</sup>	74,985
3500	3200	2 x 373 58	2 x 824	2.2 x 10 <sup>10</sup>	149,970

## 2 RIGID COPPER BARS

### 2.1. Mounting bars edgewise on supports Cat. Nos. 373 10/15/20/21/22/23

Rigid flat copper bars - edgewise mounting					
I <sub>e</sub> (A) IP ≤ 30	I <sub>the</sub> (A) IP > 30	Cat. No.	Dim. (mm)	I <sup>2</sup> t (A <sup>2</sup> s)	I <sub>cw1s</sub> (A)
110	80	373 88	12 x 2	1.2 x 10 <sup>7</sup>	3430
160	125	373 89	12 x 4	4.7 x 10 <sup>7</sup>	6865
200	160	374 33	15 x 4	7.4 x 10 <sup>7</sup>	8580
250	200	374 34	18 x 4	1 x 10 <sup>8</sup>	10,295
280	250	374 38	25 x 4	2.1 x 10 <sup>8</sup>	14,300
330	270	374 18	25 x 5	3.2 x 10 <sup>8</sup>	17,875
450	400	374 19	32 x 5	5.2 x 10 <sup>8</sup>	22,900
700	630	374 40	50 x 5	1.1 x 10 <sup>9</sup>	33,750
1150	1000	374 40	2 x (50 x 5)	4.5 x 10 <sup>9</sup>	67,500
800	700	374 41	63 x 5	1.8 x 10 <sup>9</sup>	42,500
1350	1150	374 41	2 x (63 x 5)	7.2 x 10 <sup>9</sup>	85,500
950	850	374 59	75 x 5	2.5 x 10 <sup>9</sup>	50,600
1500	1300	374 59	2 x (75 x 5)	1 x 10 <sup>10</sup>	101,000
1000	900	374 43	80 x 5	2.9 x 10 <sup>9</sup>	54,000
1650	1450	374 43	2 x (80 x 5)	1.2 x 10 <sup>10</sup>	108,000
1200	1050	374 46	100 x 5	4.5 x 10 <sup>9</sup>	67,500
1900	1600	374 46	2 x (100 x 5)	1.8 x 10 <sup>10</sup>	135,000



^ Stepped busbar in cable sleeve with supports Cat. No. 373 10

# Sizing busbars (continued)

## 2.2. Mounting bars edgewise on supports Cat. Nos. 373 24/25

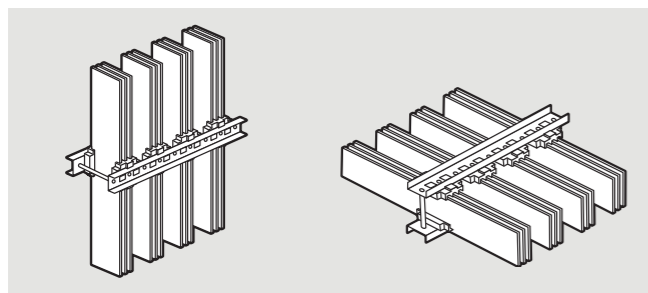

^ Bars mounted edgewise in vertical or horizontal busbars: supports in horizontal position



< Supports Cat. No. 373 24 can be used to create very high current busbars: up to 4000 A in IP 55 XL<sup>3</sup> 4000 enclosures

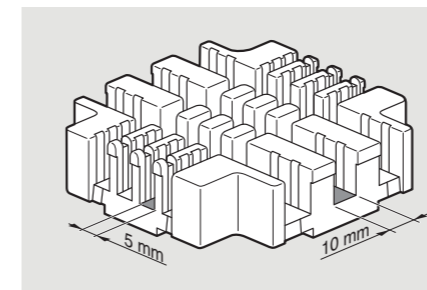

^ Simply rotate the isolating supports to take 5 or 10 mm thick bars



^ 1 to 4 bars, 5 mm thick, per pole



^ 1 to 3 bars, 10 mm thick, per pole

Rigid flat copper bars, 5 mm thick					
le (A) IP ≤ 30	lthe (A) IP > 30	Number	Dim. (mm)	I <sup>2</sup> t (A <sup>2</sup> s)	I <sub>cw1s</sub> (A)
700	630	1	50 x 5	1.14 x 10 <sup>9</sup>	33,750
1180	1020	2	50 x 5	4.56 x 10 <sup>9</sup>	67,500
1600	1380	3	50 x 5	1.03 x 10 <sup>10</sup>	101,250
2020	1720	4	50 x 5	1.82 x 10 <sup>10</sup>	135,000
800	700	1	63 x 5	1.81 x 10 <sup>9</sup>	42,525
1380	1180	2	63 x 5	7.23 x 10 <sup>9</sup>	85,050
1900	1600	3	63 x 5	1.63 x 10 <sup>10</sup>	127,575
2350	1950	4	63 x 5	2.89 x 10 <sup>10</sup>	170,100
950	850	1	75 x 5	2.56 x 10 <sup>9</sup>	50,625
1600	1400	2	75 x 5	1.03 x 10 <sup>10</sup>	101,250
2200	1900	3	75 x 5	2.31 x 10 <sup>10</sup>	151,875
2700	2300	4	75 x 5	4.10 x 10 <sup>11</sup>	202,500
1000	900	1	80 x 5	2.92 x 10 <sup>9</sup>	54,000
1700	1480	2	80 x 5	1.17 x 10 <sup>10</sup>	108,000
2350	2000	3	80 x 5	2.62 x 10 <sup>10</sup>	162,000
2850	2400	4	80 x 5	4.67 x 10 <sup>10</sup>	216,000
1200	1050	1	100 x 5	4.56 x 10 <sup>9</sup>	67,500
2050	1800	2	100 x 5	1.82 x 10 <sup>10</sup>	135,000
2900	2450	3	100 x 5	4.10 x 10 <sup>10</sup>	202,500
3500	2900	4	100 x 5	7.29 x 10 <sup>10</sup>	270,000
1450	1270	1	125 x 5	7.12 x 10 <sup>9</sup>	84,375
2500	2150	2	125 x 5	2.85 x 10 <sup>10</sup>	168,750
3450	2900	3	125 x 5	6.41 x 10 <sup>10</sup>	253,125
4150	3450	4	125 x 5	1.14 x 10 <sup>11</sup>	337,500
1750	1500	1	160 x 5 <sup>(1)</sup>	1.17 x 10 <sup>10</sup>	108,000
3050	2450	2	160 x 5 <sup>(1)</sup>	4.67 x 10 <sup>10</sup>	216,000
4200	3300	3	160 x 5 <sup>(1)</sup>	1.05 x 10 <sup>11</sup>	324,000
5000	3800	4	160 x 5 <sup>(1)</sup>	1.87 x 10 <sup>11</sup>	432,000

(1) Stainless steel threaded assembly rod, diameter 8 to be supplied separately and cut to length

Rigid flat copper bars, 10 mm thick					
le (A) IP ≤ 30	lthe (A) IP > 30	Number	Dim. (mm)	I <sup>2</sup> t (A <sup>2</sup> s)	I <sub>cw1s</sub> (A)
950	850	1	50 x 10	4.56 x 10 <sup>9</sup>	67,500
1680	1470	2	50 x 10	1.82 x 10 <sup>10</sup>	135,000
2300	2030	3	50 x 10	4.10 x 10 <sup>10</sup>	202,500
1150	1020	1	60 x 10	6.56 x 10 <sup>9</sup>	81,000
2030	1750	2	60 x 10	2.62 x 10 <sup>10</sup>	162,000
2800	2400	3	60 x 10	5.90 x 10 <sup>10</sup>	243,000
1460	1270	1	80 x 10	1.17 x 10 <sup>10</sup>	108,000
2500	2150	2	80 x 10	4.67 x 10 <sup>10</sup>	216,000
3450	2900	3	80 x 10	1.05 x 10 <sup>11</sup>	324,000
1750	1500	1	100 x 10	1.82 x 10 <sup>10</sup>	135,000
3050	2550	2	100 x 10	7.29 x 10 <sup>10</sup>	270,000
4150	3500	3	100 x 10	1.64 x 10 <sup>11</sup>	405,000
2000	1750	1	120 x 10	2.62 x 10 <sup>10</sup>	162,000
3600	2920	2	120 x 10	1.05 x 10 <sup>11</sup>	324,000
4800	4000	3	120 x 10	2.63 x 10 <sup>11</sup>	486,000

**!** Positioning bars edgewise encourages heat dissipation and is much the best option. If the bars have to be positioned flatwise (with the supports in a vertical position) the current-carrying capacities must be reduced (see next page).

# Sizing busbars (continued)

## 2.3. Mounting bars flatwise on supports Cat. Nos. 373 24/25

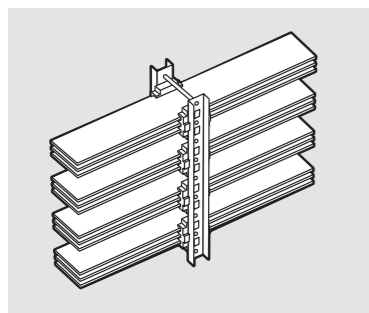

< Bars mounted flatwise in horizontal busbars: supports in vertical position

Rigid flat copper bars, 5 mm thick					
le (A) IP ≤ 30	lthe (A) IP > 30	Number	Dim. (mm)	I <sup>2</sup> t (A <sup>2</sup> s)	Icw <sub>1s</sub> (A)
500	420	1	50 x 5	1.14 x 10 <sup>9</sup>	33,750
750	630	2	50 x 5	4.56 x 10 <sup>9</sup>	67,500
1000	900	3	50 x 5	1.03 x 10 <sup>10</sup>	101,250
1120	1000	4	50 x 5	1.82 x 10 <sup>10</sup>	135,000
600	500	1	63 x 5	1.81 x 10 <sup>9</sup>	42,525
750	630	2	63 x 5	7.23 x 10 <sup>9</sup>	85,050
1100	1000	3	63 x 5	1.63 x 10 <sup>10</sup>	127,575
1350	1200	4	63 x 5	2.89 x 10 <sup>10</sup>	170,100
700	600	1	75 x 5	2.56 x 10 <sup>9</sup>	50,625
1000	850	2	75 x 5	1.03 x 10 <sup>10</sup>	101,250
1250	1100	3	75 x 5	2.31 x 10 <sup>10</sup>	151,875
1600	1400	4	75 x 5	4.10 x 10 <sup>11</sup>	202,500
750	630	1	80 x 5	2.92 x 10 <sup>9</sup>	54,000
1050	900	2	80 x 5	1.17 x 10 <sup>10</sup>	108,000
1300	1150	3	80 x 5	2.62 x 10 <sup>10</sup>	162,000
1650	1450	4	80 x 5	4.67 x 10 <sup>10</sup>	216,000
850	700	1	100 x 5	4.56 x 10 <sup>9</sup>	67,500
1200	1050	2	100 x 5	1.82 x 10 <sup>10</sup>	135,000
1600	1400	3	100 x 5	4.10 x 10 <sup>10</sup>	202,500
1900	1650	4	100 x 5	7.29 x 10 <sup>10</sup>	270,000
1000	800	1	125 x 5	7.12 x 10 <sup>9</sup>	84,375
1450	1250	2	125 x 5	2.85 x 10 <sup>10</sup>	168,750
1800	1600	3	125 x 5	6.41 x 10 <sup>10</sup>	253,125
2150	1950	4	125 x 5	1.14 x 10 <sup>11</sup>	337,500
1150	900	1	160 x 5 <sup>(1)</sup>	1.17 x 10 <sup>10</sup>	108,000
1650	1450	2	160 x 5 <sup>(1)</sup>	4.67 x 10 <sup>10</sup>	216,000
2000	1800	3	160 x 5 <sup>(1)</sup>	1.05 x 10 <sup>11</sup>	324,000
2350	2150	4	160 x 5 <sup>(1)</sup>	1.87 x 10 <sup>11</sup>	432,000

(1) Stainless steel threaded assembly rod, diameter 8, to be supplied separately and cut to length

Rigid flat copper bars, 10 mm thick					
le (A) IP ≤ 30	lthe (A) IP > 30	Number	Dim. (mm)	I <sup>2</sup> t (A <sup>2</sup> s)	Icw <sub>1s</sub> (A)
880	650	1	50 x 10	4.56 x 10 <sup>9</sup>	67,500
1250	1050	2	50 x 10	1.82 x 10 <sup>10</sup>	135,000
2000	1600	3	50 x 10	4.10 x 10 <sup>10</sup>	202,500
1000	800	1	60 x 10	6.56 x 10 <sup>9</sup>	81,000
1600	1250	2	60 x 10	2.62 x 10 <sup>10</sup>	162,000
2250	1850	3	60 x 10	5.90 x 10 <sup>10</sup>	243,000
1150	950	1	80 x 10	1.17 x 10 <sup>10</sup>	108,000
1700	1500	2	80 x 10	4.67 x 10 <sup>10</sup>	216,000
2500	2000	3	80 x 10	1.05 x 10 <sup>11</sup>	324,000
1350	1150	1	100 x 10	1.82 x 10 <sup>10</sup>	135,000
2000	1650	2	100 x 10	7.29 x 10 <sup>10</sup>	270,000
2900	2400	3	100 x 10	1.64 x 10 <sup>11</sup>	405,000
1650	1450	1	120 x 10	2.62 x 10 <sup>10</sup>	162,000
2500	2000	2	120 x 10	1.05 x 10 <sup>11</sup>	324,000
3500	3000	3	120 x 10	2.63 x 10 <sup>11</sup>	486,000

### 3 FLEXIBLE COPPER BARS

Flexible copper bars					
le (A) IP ≤ 30	lthe (A) IP > 30	Cat. No.	Dim. (mm)	I <sup>2</sup> t (A <sup>2</sup> s)	Icw <sub>1s</sub> (A)
200	160	374 10	13 x 3	2 x 10 <sup>7</sup>	4485
320	200	374 16	20 x 4	8.5 x 10 <sup>7</sup>	9200
400	250	374 11	24 x 4	1.2 x 10 <sup>8</sup>	11,000
		374 67	20 x 5		
470	320	374 17	24 x 5	1.9 x 10 <sup>8</sup>	13,800
630	400	374 12	32 x 5	3.4 x 10 <sup>8</sup>	18,400
700	500	374 44	40 x 5	5.3 x 10 <sup>8</sup>	23,000
850	630	374 57	50 x 5	8.3 x 10 <sup>8</sup>	28,700
1250	1000	374 58	50 x 10	3.3 x 10 <sup>9</sup>	57,500
2500	2000	2 x 374 58	2 x (50 x 10)	1.3 x 10 <sup>10</sup>	115,000



# Sizing busbars (continued)

## CHECKING THE PERMISSIBLE THERMAL STRESS

The thermal stress permitted by the bars must be greater than that limited by the protection device.



### Calculating the thermal stress

The maximum thermal stress value  $I^2t$  taken into consideration for a short-circuit current of less than 5 s is calculated using the formula  $I^2t = K^2S^2$ , where:

- $K = 115 \text{ As}^{0.5}/\text{mm}^2$  for flexible copper bars (max. temperature: 160°C)
- $K = 135 \text{ As}^{0.5}/\text{mm}^2$  for large cross-section rigid copper bars (width greater than 50 mm; max. temperature: 200°C)
- $K = 143 \text{ As}^{0.5}/\text{mm}^2$  for small cross-section rigid copper bars (width less than 50 mm) and C-section bars (max. temperature: 220°C)
- $K = 91 \text{ As}^{0.5}/\text{mm}^2$  for rigid aluminium bars (max. temperature: 200°C)
- $S = \text{bar cross-section in mm}^2$

The conventional value of the short-time withstand current with regard to thermal stress, in relation to a period of 1 s, is expressed by the formula:

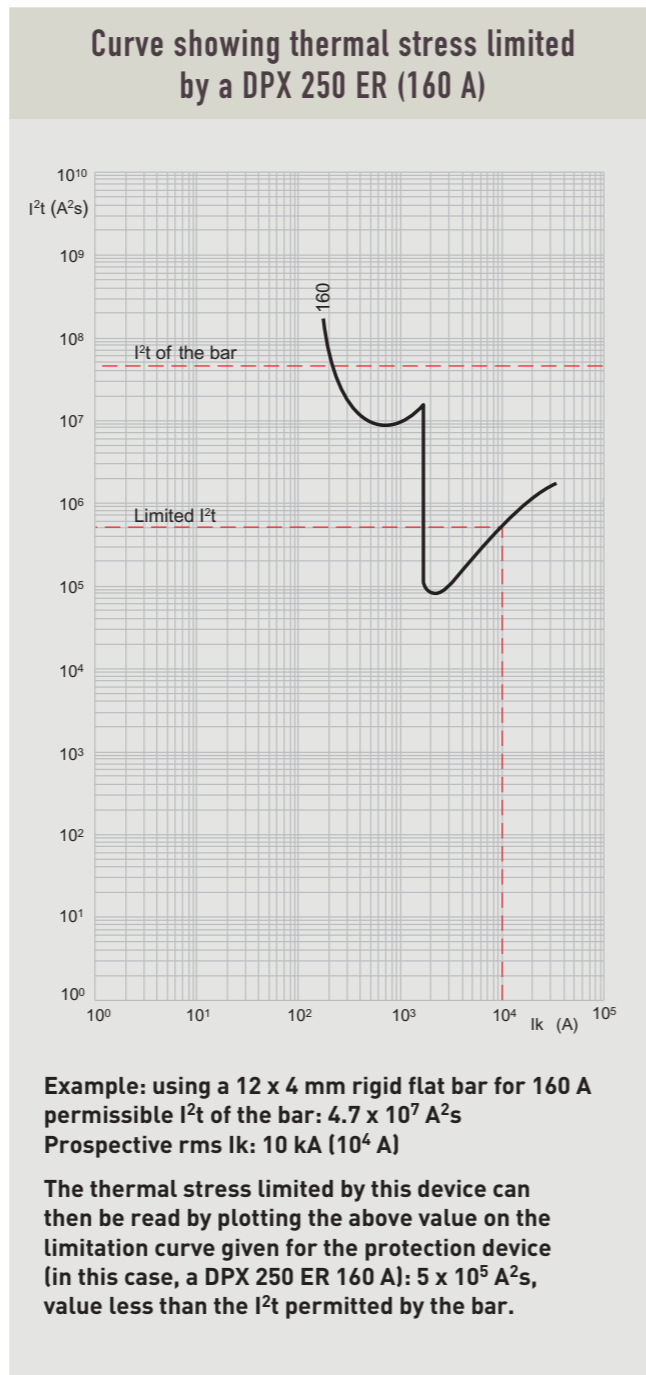
$$I_{cw1s} = \sqrt{I^2t}$$

## DETERMINING THE DISTANCES BETWEEN SUPPORTS

The distance between the supports is determined according to the electrodynamic stress generated by the short circuit. The forces exerted between the bars during a short circuit are proportional to the peak value of the short-circuit current.

### 1 RMS VALUE OF THE PROSPECTIVE SHORT-CIRCUIT CURRENT ( $I_k$ )

This is the prospective maximum value of the current which would circulate during a short circuit if there were no protection device. It depends on the type and power of the source. The actual short-circuit current will generally be lower in view of the impedance of the busbar system. The calculation of the values to be taken into account is described in Book 4: "Sizing conductors and selecting protection devices".



### Prospective $I_k$

This is the rms value of the short-circuit current that would circulate if there were no protection device.

- $I_{k1}$ : between phase and neutral
- $I_{k2}$ : between 2 phases
- $I_{k3}$ : between 3 phases

These values were formerly called  $I_{sc1}$ ,  $I_{sc2}$  and  $I_{sc3}$ . Do not confuse  $I_k$  with  $I_{pk}$ , which is defined below.



If in doubt or the actual prospective  $I_k$  value is not known, use a value of at least  $20 \times I_n$ .

### 2 PEAK CURRENT VALUE ( $I_{pk}$ )

The limited peak current is determined from the characteristics of the protection device (see Book 5: "Breaking and protection devices"). It represents the maximum (peak) value limited by this device. If there is no limiting protection device, the prospective peak value can be calculated from the prospective short-circuit current and an asymmetry coefficient (see next page).

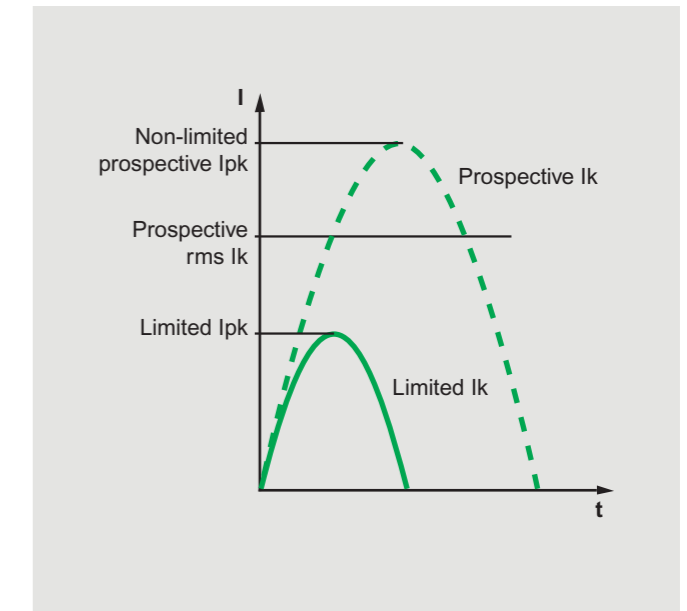

The electrodynamic forces are proportional to the square of the peak current. It is this value which must be taken into consideration when determining the distances between the supports.



# Sizing busbars (continued)

## Limiting protection device

The limitation curves of the protection devices (DX and DPX) give the limited peak current according to the prospective short-circuit current (see Book 5 "Breaking and protection devices"). The non-limited peak  $I_k$  curve corresponds to no protection.

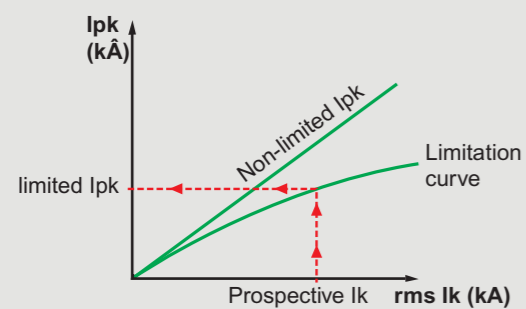

The table below gives the limited peak value ( $I_{pk}$ ) directly for the maximum prospective short-circuit value equal to the breaking capacity ( $I_{cu}$ ) of the device.

For lower prospective short-circuit values, reading the curves will provide an optimised value.

Device	Rating (A)	$I_{pk}$ (peak) max. (kA)
DPX 125	16-25	11.9
DPX 125	40-63	15
DPX 125	100-125	17
DPX 160	25	14.3
DPX 160	40 to 160	20
DPX 250 ER	100 to 250	22
DPX 250	40 to 250	27
DPX-H 250	40 to 250	34
DPX 630	250 to 630	34
DPX-H 630	250 to 630	42
DPX 1600	630 to 1600	85
DPX-H 1600	630 to 1600	110

## Non-limiting protection device

When the busbar is protected by a non-limiting protection device (for example DMX<sup>3</sup>), the maximum value of the peak current is developed during the first half-period of the short circuit. This is referred to as the asymmetric 1<sup>st</sup> peak.

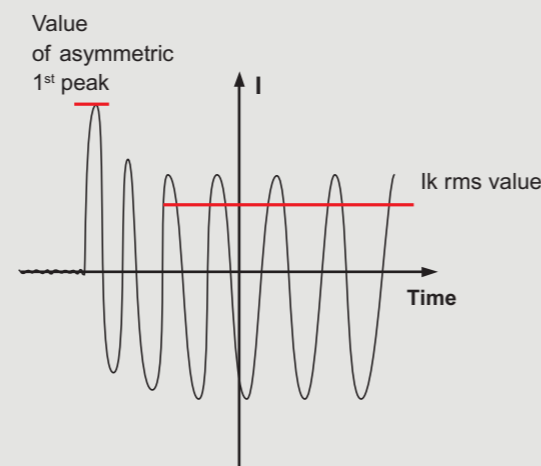

The relationship between the peak value and the rms value of the prospective short-circuit current is defined by the coefficient of asymmetry  $n$ :

$$I_{pk} (\text{peak}) = n \times \text{prospective rms } I_k$$

Prospective rms $I_k$ (kA)	$n$
$I_k \leq 5$	1.5
$5 < I_k \leq 10$	1.7
$10 < I_k \leq 20$	2
$20 < I_k \leq 50$	2.1
$50 < I_k$	2.2



The electrodynamic forces that are exerted between conductors, in particular in busbars, are the result of the interaction of the magnetic fields produced by the current flowing through them. These forces are proportional to the square of the peak current intensity that can be recorded in A or kA. When there is a short circuit, these forces can become considerable (several hundred daN) and cause deformation of the bars or breaking of the supports. The calculation of the forces, prior to the tests, is the result of applying Laplace's law, which states that when a conductor through which a current  $i_1$  passes is placed in a magnetic field  $H$  with induction  $B$ , each individual element  $dl$  of this conductor is subjected to a force of  $dF = idl \wedge B$ . If the magnetic field originates from another conductor through which  $i_2$  passes, there is then an interaction of each of the fields  $H_1$  and  $H_2$  and forces  $F_1$  and  $F_2$  generated by  $B_1$  and  $B_2$ .

The directions of the vectors are given by Ampère's law. If currents  $i_1$  and  $i_2$  circulate in the same direction, they attract, if they circulate in opposite directions, they repel.

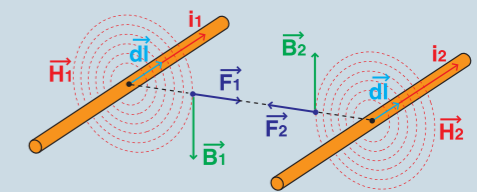

^ Schematic representation at a point in space (Biot-Savart law)



## General formula for calculating the forces in the event of a short circuit

The calculation of the forces in the event of short circuits ( $F_{max}$ ), can be defined as follows:

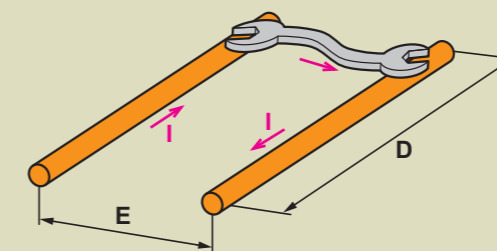

$D$ : length of the conductor (distance between supports in the case of bars)

$E$ : spacing between conductors

$$F_{max} = 2 \times I^2 \times \frac{D}{E} \times 10^{-8} \text{ with } F \text{ in daN, } I \text{ in A peak, and } D \text{ and } E \text{ in the same unit.}$$

In practice, this formula is only applicable to very long ( $D > 20 E$ ) round conductors. When  $D$  is shorter, a correction, called the "end factor" is applied:

$$\text{- For } 4 \leq \frac{D}{E} < 20, \text{ use } F_{max} = 2 \times I^2 \times \left(\frac{D}{E} - 1\right) \times 10^{-8}$$

$$\text{- For } \frac{D}{E} < 4, \text{ use } F_{max} = 2 \times I^2 \times \left[\sqrt{\left(\frac{D}{E}\right)^2 + 1} - 1\right] \times 10^{-8}$$

Correction factors must be inserted in these formulae to take account of the layout and shape of the conductors when they are not round.

# Sizing busbars (continued)

## 3 PRACTICAL DETERMINATION OF THE DISTANCES BETWEEN THE SUPPORTS ACCORDING TO THE PEAK CURRENT (I<sub>pk</sub>)

The following tables can be used to determine the maximum distances D (in mm) between the supports, based on the required I<sub>pk</sub> value, and thus create busbars. The shorter the distance between the supports, the higher the permissible I<sub>k</sub>. With single pole supports, it is also possible to vary the spacing between bars E. The wider the spacing between bars, the higher the permissible I<sub>k</sub>. Distance D' after the last support must always be less than 30% of distance D.

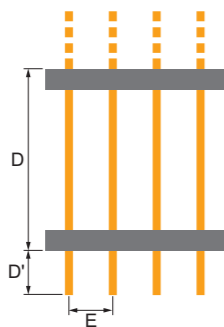

**!** The I<sub>pk</sub> values to be taken into account must be determined according to the limitation curves for the devices (see p. 12)

Maximum distance D (in mm) between single pole supports (E adjustable)								
Supports	373 98				374 37			
Bars	373 88 (12 x 2) or 373 89 (12 x 4)				374 33 (15 x 4), 374 34 (18 x 4) or 374 38 (25 x 4)			
E (mm)	50	75	100	125	50	75	100	125
I <sub>pk</sub> (peak) (in kA)	10	400	600	800	350	600	750	
	15	300	450	600	250	400	500	700
	20	250	350	450	150	225	300	375
	25	200	250	300	125	150	200	250
	30				100	125	150	175
						100	125	150

Maximum distance D (in mm) between multipole supports Cat. Nos. 373 20/21 (E fixed: 75 mm)

Support	373 20				373 21							
	1 flat bar per pole				1 C-section bar per pole			1 flat bar per pole				
Bars 50 mm thick	374 18 (25 x 5)	374 19 (32 x 5)	374 40 (50 x 5)	374 41 (63 x 5)	155 mm <sup>2</sup>	265 mm <sup>2</sup>	440 mm <sup>2</sup>	374 40 (50 x 5)	374 41 (63 x 5)	374 59 (75 x 5)	374 43 (80 x 5)	
I <sub>pk</sub> (peak) (in kA)	10	800	900		1100	1600	1600	1000	1200	1200	1200	
	15	600	600		800	1000	1300	800	900	1000	1000	
	20	450	500	600	700	600	800	1000	650	700	750	
	25	350	400	500	550	450	650	800	500	600	600	
	30	300	350	400	450	400	550	700	400	500	550	
	35	250	300	350	400	350	450	600	350	450	450	
	40	200	250	275	300	300	400	550	300	350	400	
	45	200	200	225	250	250	350	500	300	300	350	
	50	150	150	200	200	250	300	450	250	250	300	
	60	125	125	150	150	200	300	400	200	250	250	
	70	100	100	150	150	150	250	350	150	200	200	
	80			100	100		200	300	100	150	200	
90						200	250	100	150	200		
100						150	250	100	150	150		
110						150	200	100	100	150		
120						150	200	100	100	100		

Maximum distance D (in mm) for multipole supports Cat. Nos. 373 22/23 (E fixed: 75 mm)

Supports	373 22/23 and 374 53									
	Bars 50 mm thick	1 flat bar per pole					2 flat bars per pole			
374 40 (50 x 5)		374 41 (63 x 5)	374 59 (75 x 5)	374 43 (80 x 5)	374 46 (100 x 5)	374 40 (50 x 5)	374 41 (63 x 5)	374 59 (75 x 5)	374 43 (80 x 5)	374 46 (100 x 5)
I <sub>pk</sub> (peak) (in kA)	10	1000	1200	1200	1200	1200				
	15	800	900	1000	1000	1200				
	20	650	700	750	750	900				
	25	500	600	600	600	700				
	30	400	500	550	550	600	700	800		
	35	350	450	450	450	550				
	40	300	350	400	400	450	550	600	650	700
	45	300	300	350	350	400				
	50	250	250	300	300	350	450	500	500	550
	60	200	250	250	250	300	350	400	400	450
	70	150	200	250	250	250	250	350	350	350
	80	100	150	200	200	200	250	300	300	300
90	100	150	200	200	200	200	250	300	300	
100	100	150	150	150	150	200	200	250	250	
110	100	100	150	150	150	200	150	200	200	
120	100	100	100	100	100	150	150	200	200	

Maximum distance D (in mm) between multipole supports Cat. Nos. 373 96, 374 10/15/32/36 (E fixed)

Supports	373 96				374 15				374 10			
	373 88 (12 x 2)	373 89 (12 x 4)	374 33/34 (15 x 4) (18 x 4)	374 36 (25 x 4)	374 34 (18 x 4)	374 18 (25 x 5)	374 19 (32 x 5)	374 34 (18 x 4)	374 38 (25 x 4)	374 18 (25 x 5)	374 19 (32 x 5)	
I <sub>pk</sub> (peak) (in kA)	10	200	400	550	650	1000	1200	1500	550	650	800	900
	15	150	300	400	500	700	1000	1200	400	600	700	800
	20	125	200	300	400	550	750	950	300	450	550	700
	25	100	150	200	350	400	600	750	250	350	400	500
	30			150	200	350	500	650	200	300	350	400
	35			100	150	300	400	550	150	250	300	350
	40				100	250	350	450	150	200	300	300
	45								150	200	200	
	50					200	300	400		150	175	100
	55								100	150	100	
	60					200	250	300		150		
	70					150	200	250				
80					150	200	250					

# Sizing busbars (continued)

Maximum distance D (in mm) between multipole supports Cat. Nos. 373 24/25 with 5 mm thick bars																			
Supports		373 24, 373 25, 374 54 																	
Bars	Ip <sub>pk</sub> (peak) (in kA)	1 bar per pole				2 bars per pole				3 bars per pole				4 bars per pole					
		50 x 5	63 x 5	75 x 5 80 x 5	100 x 5	125 x 5	50 x 5	63 x 5	75 x 5 80 x 5	100 x 5	125 x 5	50 x 5	63 x 5	75 x 5 80 x 5	100 x 5	125 x 5	50 x 5	63 x 5	75 x 5 80 x 5
10	1550	1700	1700	1700	1700	1700	1700	1700	1700	1700									
15	1050	1200	1350	1550	1700	1550	1700	1700	1700	1700									
20	800	900	1000	1150	1350	1200	1350	1500	1700	1700	1550	1700	1700	1700	1700	1700	1700	1700	1700
25	650	750	800	950	1100	950	1100	1200	1400	1550	1250	1450	1600	1700	1700	1550	1700	1700	1700
30	550	600	700	800	900	800	900	1000	1150	1300	1050	1200	1350	1550	1700	1300	1500	1700	1700
35	450	550	600	650	800	700	800	900	1000	1150	900	1050	1150	1300	1500	1150	1250	1450	1650
40	400	450	550	600	700	600	700	800	900	1000	800	900	1050	1150	1300	1000	1100	1300	1450
45	350	400	450	550	600	550	600	700	800	900	700	800	900	1050	1200	900	1000	1150	1300
50	350	350	450	500	550	500	550	650	700	800	650	750	850	950	1050	800	900	1050	1150
60	300	300	350	400	450	400	450	550	600	700	550	600	700	800	900	650	750	850	1000
70	250	250	300	350	400	350	400	450	500	650	450	550	600	700	750	600	650	750	850
80		250	250	300	350	300	350	400	450	550	400	450	550	600	700	500	600	650	750
90			250	250	300	300	300	350	400	500	350	400	500	550	600	450	500	600	650
100				250	300	250	300	300	350	500	350	400	450	500	550	400	450	550	600
110					250	250	250	300	350	450	300	350	400	450	500	350	450	500	550
120						250		250	300	450	300	300	350	400	450	350	400	450	550
130							250	300	400	250	300	350	350	450	300	350	400	500	550
140								250	250	400	250	250	300	350	400	300	350	400	500
150									250	350	250	250	300	350	350	300	300	350	450
160										250	350		250	250	300	350	300	350	400
170											350		250	250	300	300	300	350	300
180												300		250	300	250	250	300	300
190													250	250	300	250	300	300	250
200														250	300		250	250	250
210															250	250	250	250	200
220																250	250	200	200

 The distances take the most severe short-circuit conditions into account:

- I<sub>k2</sub> two-phase short-circuit value resulting in non-uniform forces
- I<sub>k3</sub> three-phase short-circuit value resulting in maximum force on the central bar
- I<sub>k1</sub> value (phase/neutral) is generally the weakest

Maximum distance (in mm) between multipole supports Cat. Nos. 373 24/25 with 10 mm thick bars									
Supports		373 24, 373 25 and 374 54 							
Bars	Ip <sub>pk</sub> (peak) (in kA)	1 bar per pole			2 bars per pole			3 bars per pole	
		80 x 10	100 x 10	120 x 10	80 x 10	100 x 10	120 x 10	80 x 10	100 x 10
20	1700	1700	1700	1700	1700	1700	1700	1700	1700
25	1600	1700	1700	1700	1700	1700	1700	1700	1700
30	1350	1550	1700	1700	1700	1700	1700	1700	1700
35	1150	1300	1450	1700	1700	1700	1700	1700	1700
40	1050	1150	1300	1500	1700	1700	1700	1700	1700
45	900	1050	1150	1350	1550	1700	1700	1700	1700
50	850	950	1050	1200	1400	1550	1600	1700	1700
60	700	800	850	1000	1150	1300	1350	1550	1700
70	600	700	750	900	1000	1100	1150	1300	1500
80	550	600	650	750	900	1000	1000	1150	1300
90	500	550	600	700	800	900	900	1050	1100
100	450	500	550	600	700	800	850	900	950
110	400	450	500	550	650	750	750	800	800
120	350	400	450	550	600	650	700	750	750
130	350	350	400	500	550	600	650	700	700
140	300	350	400	450	500	600	600	650	650
150	300	350	350	450	500	550	550	650	600
160	250	300	350	400	450	500	550	600	500
170	250	300	300	350	450	500	500	500	500
180	250	300	300	350	400	450	500	450	450
190	250	250	300	350	400	450	450	400	400
200	200	250	300	300	350	400	450	400	400
210	200	250	250	300	350	350	400	350	350
220		250	250	300	350	300	350	300	300
230		200	250	300	300	300	300	300	300
240			200	250	300	250	300	250	250
250				200	250	300	250	250	250

 **Additional supports**  
Cat. Nos. 373 23 and 373 25

Additional supports are used in addition to fixed supports to hold the bars together and maintain the recommended spacing (Ik withstand).



# Sizing busbars (continued)

Maximum distance D (in mm) between multipole supports Cat. Nos. 373 66/67 and 373 68/69

Supports	373 66/67					373 68/69					
	1 C-section aluminium bar per pole					1 C-section aluminium bar per pole					
Bar	373 54	373 55	373 56	373 57	373 58	373 54	373 55	373 56	373 57	373 58	
I <sub>pk</sub> (in kA)	30	1600	1600	1600	1600	1600	1600	1600	1600	1600	
	40	1000	1000	1000	1000	1000	1000	1000	1000	1000	
	52	800	800	800	800	800	800	800	800	800	
	63	700	700	700	700	700	600	600	600	600	
	73	600	600	600	600	600	500	500	500	500	
	80	600	600	600	600	600	500	500	500	500	
	94	500	500	500	500	500	400	400	400	400	
	105	500	500	500	500	500	400	400	400	400	
	132	-	-	500	500	500	-	-	400	400	400
	154	-	-	400	400	400	-	-	300	300	300



< Cables are connected to C-section aluminium bars without drilling, using hammer head screws

## MAGNETIC EFFECTS ASSOCIATED WITH BUSBARS

The magnetic effects can be divided into transient effects, which are the short-circuit electrodynamic forces, and permanent effects created by induction due to circulation of high currents. The effects of induction have several consequences:

- Increased impedance in the conductors due to the effects of mutual inductance

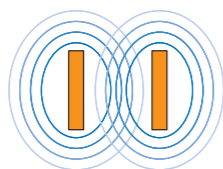

- Temperature rise linked to magnetic saturation of the materials in the fields formed around the conductors

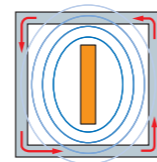

- Possible interference in sensitive devices for which it is recommended that minimum cohabitation distances are observed (see Book 8)

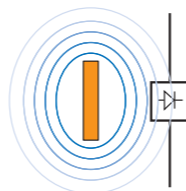

## Measuring the magnetic field lines around a busbar



Magnetic field values are generally expressed using two units:

- The tesla (T) represents the magnetic induction value, which, directed perpendicular to a 1 m<sup>2</sup> surface, produces a flux of 1 weber across this surface. As the tesla expresses a very high value, its sub-units are generally used: the millitesla (mT) and the microtesla (μT). The old unit, the gauss (G) should not be used (1 T = 10,000 G).
- The ampere per metre (A/m), a non-SI unit, formerly called the “ampere-turn per metre”, indicates the intensity of the magnetic field created at the centre of a 1 m diameter circular circuit crossed by a constant 1 A current.

The induction B (in T) and the field H (in A/m) are linked by the formula:

- $B = \mu_0 \mu_r H$  where:
- $\mu_0 = 4 \pi \cdot 10^{-7}$  (magnetic permeability of air or the vacuum)
  - $\mu_r = 1$  (relative permeability of iron)
- giving:  $1 \mu T = 1.25 A/m$  and  $1 A/m = 0.8 \mu T$

The recommended mounting distances correspond to magnetic field values read close to a busbar at 4000 A:

- 0.1 mT (125 A/m) at a distance of 1 m (sensitive equipment)
- 0.5 mT (625 A/m) at a distance of 50 cm (limited sensitivity equipment)
- 1 mT (1250 A/m) at a distance of 30 cm (very low sensitivity equipment)

^ A knowledge of the induction phenomena generated by the power conductors enables appropriate mounting and cohabitation conditions to be stipulated.

+ The formation of magnetic fields around high power busbars **MUST** be prevented. The structures of XL<sup>3</sup> enclosures, which incorporate non-magnetic elements (which create air gaps), are ideal for the highest currents.



^ The corner pieces of XL<sup>3</sup> 4000 enclosures are made of non-magnetic alloy

! The specified separation distances between conductors and devices will be increased in the event of cohabitation with very high power busbars (up to 4000 A). If there are no instructions from the manufacturers, the minimum distances will be increased to:

- 30 cm for devices with very low sensitivity (fuses, non residual current devices, connections, MCCBs, etc.)
- 50 cm for devices with limited sensitivity (secondary circuit breakers, including RCDs, relays, contactors, transformers, etc.)
- 1 m for sensitive devices (electronics and digital measuring devices, bus-based systems, remote controls, electronic switches, etc.)
- Devices which are very sensitive to magnetic fields (analogue gauge, meters, oscillographs, cathode ray tubes, etc.) may require greater separation distances.

# Sizing busbars (continued)

The circulation of high currents in busbars leads to the induction of magnetic fields in the surrounding exposed metal conductive parts (enclosure panels, frames and chassis, etc.). The phenomenon is similar to that used for creating electromagnetic shielding, but in this case it must be limited to avoid temperature rises in these exposed conductive parts and the circulation of induced currents.

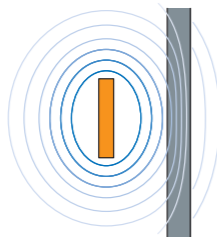

**+**

**^ Supports on aluminium crosspieces to prevent the formation of magnetic fields.**

**^ Non-magnetic stainless steel screws perform the same function on supports Cat. No. 373 24**

**Minimum distances between bars and metal panels**

**Induction is higher facing the flat surface of bars (distance X). Above 2500 A, maintain minimum distances: X ≥ 150 mm and Y ≥ 100 mm.**

**+** In practice the values of the magnetic fields generated by the power bars considerably exceed the standard values for exposure of the devices. Much more severe tests, such as those to undergone by Lexic range devices, are therefore essential to ensure they will operate correctly in these conditions.

**!** In addition to the heat dissipation aspects which require the provision of adequately sized dissipation volumes, it is essential to take these notions of magnetic induction in the exposed conductive parts of the enclosures into consideration by ensuring they are large enough to maintain the appropriate distances between bars and walls. Above 2500 A, this can lead to providing enclosures (for example, at the rear) just to take the busbars.

## CHECKING THE INSULATION CHARACTERISTICS

### 1 INSULATION VOLTAGE $U_i$

This must be the same as or higher than the maximum value of the rated operating voltage for the assembly, or the reference voltage. The latter depends on the mains supply voltage and the structure of the source (star, delta, with or without neutral).

Reference voltage values (in V) to be taken into consideration according to the nominal supply voltage

Nominal power supply voltage	For insulation between phases	For insulation between phase and neutral	
	All supplies	4-wire three phase supplies neutral connected to earth	3-wire three phase supplies not connected to earth or one phase connected to earth
60	63	32	63
110 - 120 - 127	125	80	125
160	160	-	160
208	200	125	200
220 - 230 - 240	250	160	250
300	320	-	320
380 - 400 - 415	400	250	400
440	500	250	500
480 - 500	500	320	500
575	630	400	680
600	630	-	630
660 - 690	630	400	630
720 - 830	800	500	800
960	1000	630	1000
1000	1000	-	1000

**!** A check must be carried out to ensure that the reference voltage is not higher than the insulation voltage  $U_i$  of the devices, busbars and distribution blocks.

**+** The insulation between live conductors and the earth of the Legrand busbar supports and distribution blocks is at least equal to that between phases. The insulation value  $U_i$  can be used for all mains supplies.

# Sizing busbars (continued)

## 2 IMPULSE WITHSTAND VOLTAGE $U_{imp}$

This value characterises the permissible overvoltage level in the form of a voltage wave representative of a lightning strike.

Its value (in kV) depends on the mains voltage, and also the location in the installation.

It is highest at the origin of the installation (upstream of the incoming MCB or the transformer).

Equipment can be designated or marked according to two methods.

- **Two values indicated** (example: 230/400 V): these refer to a 4-wire three-phase supply (star configuration). The lower value is the voltage between phase and neutral, and the higher is the value between phases.

- **A single value indicated** (example: 400 V): this normally refers to a 3-wire single phase or three phase supply with no earth connection (or with one phase connected to earth) and for which the phase-earth voltage must be considered capable of reaching the value of the phase-to-phase voltage (full voltage between phases).

All the specifications relating to insulation are defined by international standard IEC 60664-1 "Insulation coordination in low-voltage systems (networks)". They are also contained in standards IEC 60439-1 and IEC 60947-1.

Legrand busbar supports are designed and tested for the harshest operating conditions corresponding to the highest overvoltage risks. The  $U_{imp}$  value characterises this safety requirement.

Insulation characteristics of busbar supports (Degree of pollution: 3), similar to industrial applications

Cat. No.	373 98 374 37	373 15/96	373 10/20/21/22/23/24/25 37 4 14/32/36/53/54
$U_i$ (V)	500	690	1000
$U_{imp}$ (kV)	8	8	12

Impulse voltage values to be taken into consideration according to the voltage in relation to earth and location in the installation

Maximum rated operating voltage value in relation to earth (rms or DC value)  (V)	Preferred rated impulse withstand voltage values (1.2/50 $\mu$ s) at 2000 m (in kV)							
	To be considered generally				Can be considered for underground power supplies			
	Overvoltage category				Overvoltage category			
	IV	III	II	I	IV	III	II	I
	Installation origin level	Distribution level	Load level (devices, equipment)	Specially protected level	Installation origin level	Distribution level	Load level (devices, equipment)	Specially protected level
50	51.5	0.8	0.5	0.33	0.8	0.5	0.33	-
100	2.5	1.5	0.8	0.5	1.5	0.8	0.5	0.33
150	4	2.5	1.5	0.8	2.5	1.5	0.8	0.5
300	6	4	2.5	1.5	4	2.5	1.5	0.8
600	8	6	4	2.5	6	4	2.5	1.5
1000	12	8	6	4	8	6	4	2.5

NB: The impulse withstand voltage given for an altitude of 2000 m implies that tests are carried out at higher values at sea level: 7.4 kV for 6 kV - 9.8 kV for 8 kV - 14.8 kV for 12 kV.

Design of the isolating supports for busbars and distribution blocks

The insulation voltage  $U_i$  of supports and distribution blocks is determined by measuring the creepage distances, by the insulating properties of the material and by the degree of pollution.

- The creepage distance is the distance measured on the surface of the insulation in the most unfavourable conditions or positions between the live parts (phases, phases and neutral) and between these parts and the exposed conductive part.
- The insulating properties of the material are characterised amongst other things by the comparative tracking index (CTI). The higher this value, the less the insulation will be damaged by conductive pollution deposits (Legrand busbar supports, made of fibreglass reinforced polyamide 6.6, have an index of more than 400).
- The degree of pollution characterises the risk of conductive pollution deposits, using a number from 1 to 4:
  - 1 : No pollution
  - 2 : No pollution and temporary condensation
  - 3 : Conductive pollution possible
  - 4 : Persistent pollution

Level 2 is similar to household, commercial and residential applications  
Level 3 is similar to industrial applications

A. Conductive elements  
B. Screen  
C. Distance in air or clearance  
D. Creepage distance

^ General principle of measuring the clearances and creepage distances



# Shaping and connecting bars

Creating busbars generally involves machining, bending and shaping which require a high degree of expertise to avoid weakening the bars or creating stray stresses. The same applies to connections between bars, whose quality depends on the sizes and conditions of the contact areas, and the pressure of this contact (number of screws and effectiveness of tightening).

## RIGID BARS

### 1 SIZES OF THE CONTACT AREAS

The contact area ( $S_c$ ) must be at least 5 times the cross-section of the bar ( $S_b$ ).  $S_c > 5 \times S_b$

For main busbar continuity links, it is advisable to establish contacts along the entire length of the bar in order to ensure optimum heat transfer.

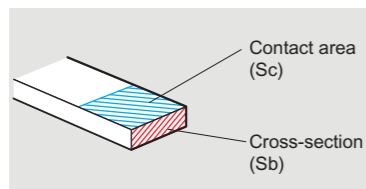

**!** Connection on extension rod, adaptor or spreader

**Preferable**                      **Avoid**

### 2 CONTACT PRESSURE

The contact pressure between bars is provided using screws whose size, quality, number and tightening torque are selected according to the current and the sizes of the bars.

Too high a tightening torque or not enough screws can lead to distortions which reduce the contact area. It is therefore advisable to distribute the pressure by increasing the number of tightening points and using wide washers or back-plates.

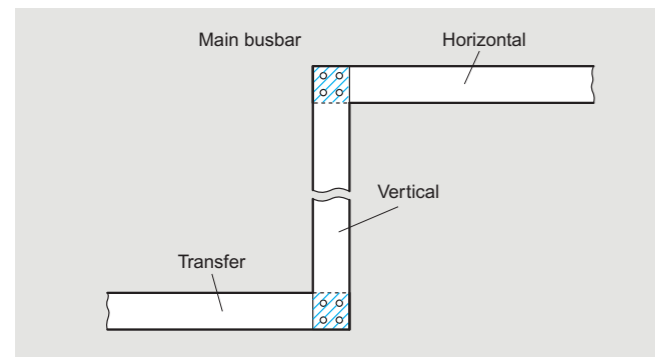
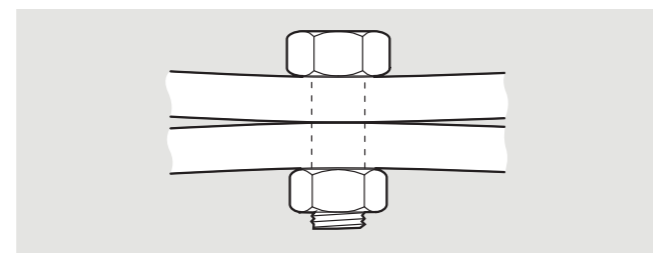

For branch busbars, the contact area can be smaller, complying with the condition  $S_c > 5 \times S_b$ . For equipment connection plates, contact must be made over the whole surface of the plate for use at nominal current.

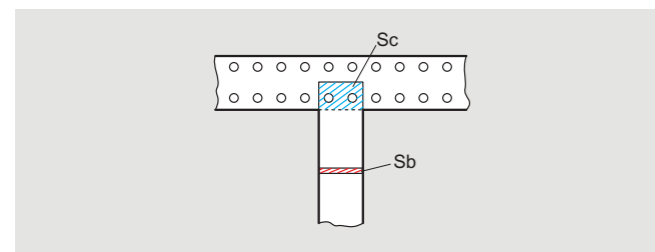

### Devices to prevent loosening



^ Applying a mark (paint, brittle coating) will show any loosening and can also be used to check that tightening has been carried out correctly (tell-tale)

### Recommended screws and minimum characteristics

I (A)		Bar width (mm)	Number of screws	Ø Screw (mm)	Minimum quantity	Tightening torque (Nm)
1 bar	2+ bars					
≤ 250	-	≤ 25	1	M8	8-8	15/20
	-		2	M6	8-8	10/15
≤ 400	-	≤ 32	1	M10	6-8	30/35
	-		2	M8	8-8	15/20
≤ 630	-	≤ 50	1	M12	6-8	50/60
	-		2	M10	6-8	30/35
800	1250	≤ 80	4	M8	8-8	15/20
			4	M10	6-8	30/35
1000	1600	≤ 100	4	M10	6-8	30/35
			2	M12	6-8	50/60
1600	2500	≤ 125	4	M12	6-8	50/60

Tightening torques that are too high lead to the limit of elasticity of the bolts being exceeded and creeping of the copper.



^ Connection on 120 x 10 bars (4000 A)



^ Double connection: 100 x 10 bars (3200 A) and 80 x 10 bars (2500 A) on common 120 x 10 bars

### C-section aluminium bars

The lugs or flexible bars connect directly with no need to add washers or spacers

# Shaping and connecting bars (continued)

### 3 CONDITION OF THE CONTACT AREAS

Apart from pronounced oxidation (significant blackening or presence of copper carbonate or "verdigris"), bars do not require any special preparation. Cleaning with acidified water is prohibited, as, apart from the risks, it requires neutralisation and rinsing. Surface sanding (240/400 grain) can be carried out, complying with the direction of sanding so that the "scratches" on bars that are in contact are perpendicular.

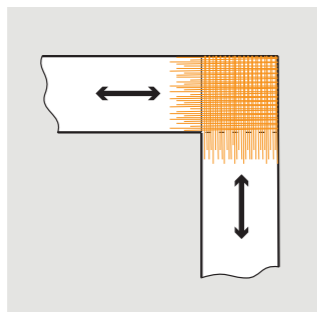

^ The hydraulic punch is used to make precision holes easily ... and with no chips

### 4 MACHINING COPPER BARS

Copper is a soft, "greasy" or "sticky" metal in terms used in the trade. Shaping is generally carried out dry, but lubrication is necessary for high-speed cutting or drilling operations (up to 50 m/mn).

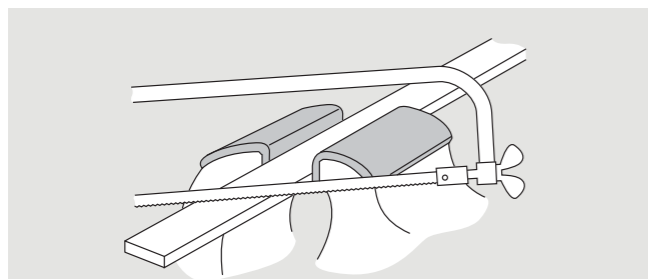

^ Sawing (8D medium tooth) in a clamping vice

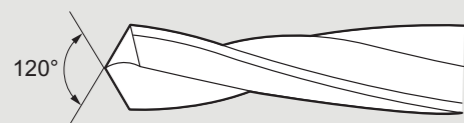

^ It is possible to make holes with drills for steel, but it is preferable to use special drills (with elongated flutes for easy detachment of chips)

### 5 BENDING BARS

It is strongly recommended that a full-scale drawing is made of the bars, in particular for bends and stacking of bars.

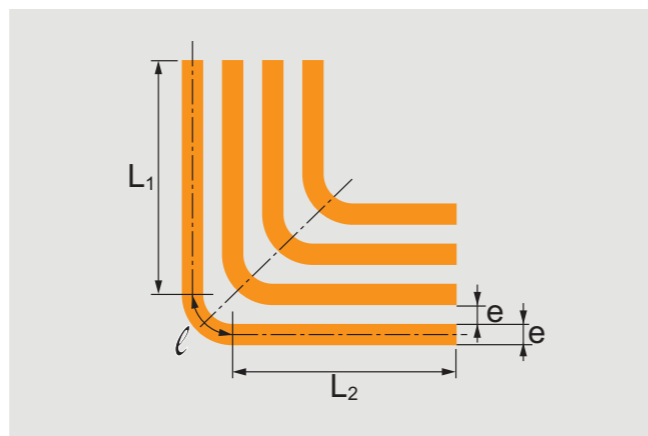

The bars are separated by their thickness "e". The total centre line length before bending is the sum of the straight parts (L1 + L2) that are not subject to any distortion and the length  $\ell$  of the curved elements on the neutral line (in theory at the centre of the thickness of the metal).

#### Calculation of the length $\ell$

**Bending to 90°**  
 $\ell = \frac{2\pi R}{4} = \frac{\pi}{2} (2r + e)$   
 useful formula:  $\ell = R \times 1.57$

**Bending to any angle  $\alpha$**   
 $\ell = \frac{\pi(180-\alpha)}{360} (2r + e)$

r: bending radius (or radius of the tool)  
 R: radius to the neutral line  $R = r + \frac{e}{2}$   
 $\ell$ : length to the neutral line

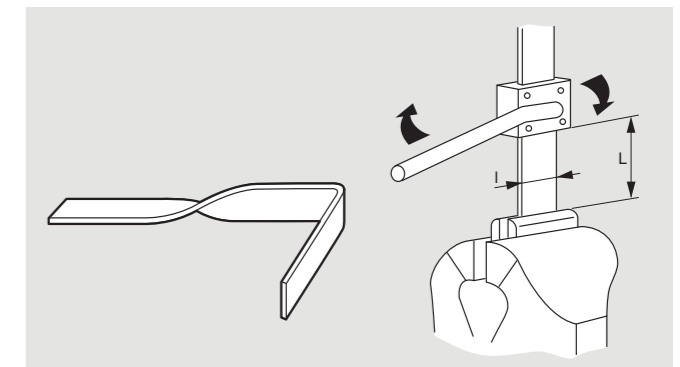

^ Creating a twist. The length L of the twist is at least twice the width l of the bar

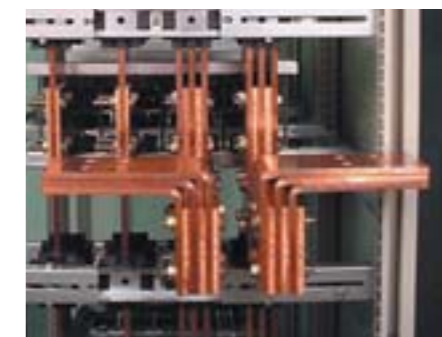

< Example of bending three bars one on top of the other to create power sockets

**!** The calculation must be carried out based on the tool used and its actual bending radius r.

Bending on bending machine:  $r = 1 \text{ to } 2e$

Bending on V-block:  $r \text{ min.} = e$

Bending a 10 mm thick copper bar on a portable hydraulic tool

# Shaping and connecting bars (continued)

## FLEXIBLE BARS

Flexible bars can be used for making connections on devices or for creating links that can be adapted to virtually any requirement. Guaranteeing safety and high quality finish, they provide an undeniably attractive touch.

Based on the most commonly used sizes and the electrical capacities of the usual nominal values, the Legrand range of flexible bars is suitable for most connection or linking requirements.

As with any conductor, the current-carrying capacities of flexible bars may vary according to the conditions of use:

- Ambient temperature (actual in enclosure)
- Period of use (continuous or cyclic load), or installation conditions
- Bars on their own or grouped together (side by side in contact or with spacers)
- Ventilation: natural (IP ≤ 30), forced (fan) or none (IP > 30)
- Vertical or horizontal routing.

The considerable variability of all these conditions leads to very different current-carrying capacities (in a ratio of 1 to 2, or even more).

Incorrect use can result in temperature rises that are incompatible with the insulation, disturbance or even damage to connected or surrounding equipment. Flexible bars are shaped manually without the need for any special tools, although some dexterity is required to achieve a perfect finish.



**The currents  $I_e$  (A) and  $I_{the}$  (A) of Legrand flexible bars are given for the following conditions:**

- $I_e$  (IP ≤ 30): maximum permanent current-carrying capacity in open or ventilated enclosures, the positions of the bars and relative distance between them allow correct cooling. The temperature in the enclosure must be similar to the ambient temperature.
- $I_{the}$  (IP > 30): maximum permanent current-carrying capacity in sealed enclosures. The bars can be installed close to one another, but must not be in contact. The temperature in the enclosure can reach 50°C.



Flexible bars have higher current-carrying capacities than cables or rigid bars with the same cross-section due to their lamellar structure (limitation of eddy currents), their shape (better heat dissipation) and their permissible temperature (105°C high temperature PVC insulation).



< Connection of a DPX to a distribution block using flexible bars

### Current-carrying capacities of Legrand flexible bars

Cat. No.	374 10	374 16	374 11	374 67	374 17	374 12	374 44	374 57	374 58
Cross-section (mm)	13 x 3	20 x 4	24 x 4	20 x 5	24 x 5	32 x 5	40 x 5	50 x 5	50 x 10
$I_e$ (A) IP ≤ 30	200	320	400	400	470	630	700	850	1250
$I_{the}$ (A) IP > 30	160	200	250	250	520	400	500	630	800

## CURRENT TRANSFORMERS (CT)

Measuring devices such as ammeters, electricity meters and multifunction control units are connected via current transformers which provide a current of between 0 and 5 A. The transformation ratio will be chosen according to the maximum current to be measured.

These transformers can be fixed directly on flat, flexible or rigid bars.

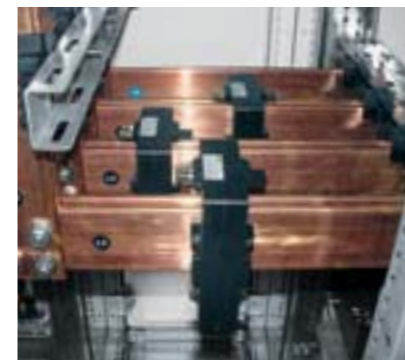

^ Fixing CTs on busbars



Cat. No.	Transformation ratio	Dimensions (mm)	Aperture for cables Ø max. (mm)	Aperture for bar width x thick. (mm)	Fixing on rail	Fixing on plate	Direct fixing on cables or bars
<b>Single phase CTs</b>							
046 31	50/5		21	16 x 12.5	●	●	
046 34	100/5						
046 36	200/5						
047 75	300/5		23	20.5 x 12.5 25.5 x 11.5 30.5 x 10.5	●	●	●
046 38	400/5		35	40.5 x 10.5	●		●
047 76	600/5						
047 77	800/5			32 x 65			●
047 78	1000/5						
047 79	1250/5			34 x 84			●
046 45	1500/5						
046 46	2000/5			38 x 127			●
047 80	2500/5						
046 48	4000/5			54 x 127			●
<b>Three-phase CTs</b>							
046 98	250/5		8	20.5 x 5.5			●
046 99	400/5			30.5 x 5.5			●



# Distribution blocks

The distribution block is a prefabricated device. It is therefore sized to suit its rated current and, unlike busbars, does not require manufacturing definitions. However, the diversity of distribution blocks according to their capacity, their connection mode and their installation calls for careful selection while adhering to precise standards.

## Possible locations for distribution blocks

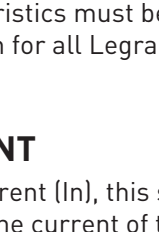
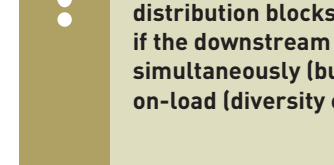
Location	Example of Legrand solution
At panel supply end or output for connecting incoming or outgoing conductors	 Connection boxes
Directly at the output of an upstream device	 Distribution terminals
Directly at the input of downstream devices	 Supply busbars
Independently of the upstream and downstream devices with the need to connect the input and outputs	 Modular distribution blocks

## CHARACTERISTICS OF DISTRIBUTION BLOCKS

Before making the final choice of product, a few essential characteristics must be checked. These are given for all Legrand distribution blocks.

### 1 RATED CURRENT

Often called nominal current ( $I_n$ ), this should be chosen according to the current of the upstream device or the cross-section of the power supply conductor.

As a general rule, use a distribution block with the same current as or immediately above that of the main device ( $I_t$ ), ensuring that the sum of the currents of the distributed circuits is not higher than the nominal current ( $I_n$ ) of the distribution block.

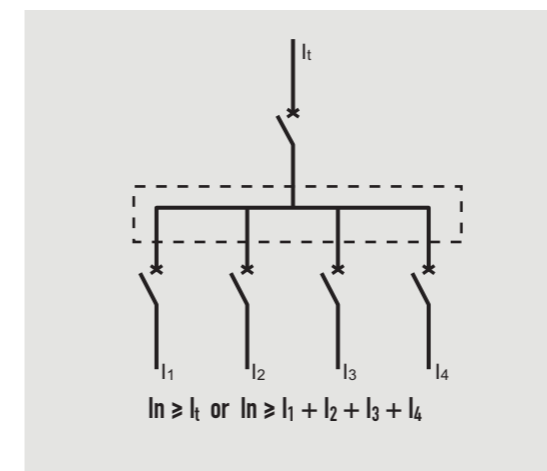

**!** In practice, it is possible to select one or more distribution blocks with a lower nominal current if the downstream circuits are not on-load simultaneously (bulking factor) or are not 100% on-load (diversity coefficient) (see Book 2).

$I_1 + I_2 + I_3 + I_4 = I$



125 A modular distribution block equipped with an additional neutral terminal block >



When a change of conductor cross-section or type results in a reduction of the current-carrying capacity, standard IEC 60364-473 stipulates that a protection device must be placed at this point. In certain conditions, it is however possible to depart from this rule (see p. 03)

# Distribution blocks (continued)

## 2 PERMISSIBLE SHORT-CIRCUIT VALUE

- Value  $I_{cw}$  characterises the conventional current-carrying capacity for 1 s from the point of view of thermal stress.
- Value  $I_{pk}$  characterises the maximum peak current permitted by the distribution block. This value must be higher than that limited by the upstream protection device for the prospective short circuit.

## 3 INSULATION VALUE

- The insulation voltage  $U_i$  must be at least equal to the maximum value of the rated operating voltage of the assembly, or the reference voltage (see p. 23).
- The impulse withstand voltage  $U_{imp}$  characterises the permissible overvoltage level when there is a lightning strike (see p. 24).



Legrand distribution blocks are designed to resist thermal stress at least as high as that of the conductor with the cross-section corresponding to the nominal current, which means that no other checks are usually necessary. They are tested for the harshest operating conditions corresponding to the highest overvoltage risks. The  $U_{imp}$  value characterises this safety requirement.



It is not generally necessary to check the  $I_{pk}$  when the distribution block is protected by a device with the same nominal current. However it must be checked if the rating of the upstream device is higher than the current of the distribution block.



### Concern for maximum safety

Legrand distribution blocks are designed to minimise the risks of short circuits between poles: individual insulation of the bars on modular distribution blocks, partitioning of power distribution blocks, new totally isolated concept of single pole distribution blocks Cat. Nos. 048 71/73/83, all innovations to increase safety. Providing the highest level of fire resistance (960°C incandescent wire in accordance with standard IEC 60695-2-1), Legrand distribution blocks meet the standard requirement for non-proximity of combustible materials.



< 160 A modular distribution block Cat. No. 048 87: total insulation of each pole

## 4 CONNECTION METHOD

### 4.1. Direct connection

The conductors are connected directly in the terminals without any special preparation. This is the preferred on-site method for H07 V-U, H07 V-R rigid conductors and FR-N05 VV-U and FR-N05 VV-R cables. Use of a ferrule (such as Starfix™) is recommended for flexible conductors (H07 V-K) connected in butt terminals (under the body of the screw) and for external flexible cables (H07 RN-F, A05 RR-F, etc.) which may be subject to pulling.

### 4.2. Connection via terminals

This type of connection is normally used for large cross-section conductors, and mainly for panels that are wired in the factory. It is characterised by excellent mechanical withstand, excellent electrical reliability and its ease of connection/disconnection.



63/100 A terminal blocks, 125/160 A modular distribution blocks and 250 A Lexiclic distribution blocks can be connected directly. 125/250 A extra-flat distribution blocks and 125/400 A stepped distribution blocks are connected via terminals.

Correspondence between cross-section (in mm<sup>2</sup>) and template (Ø in mm)

Cross-section (mm <sup>2</sup> )	Template for circular shape B rigid conductor (IEC 60947-1)	Template for flexible conductor with or without cable end
	Ø in mm	Ø in mm
1	1.5	2
1.5	1.9	2.4
2.5	2.4	2.9
4	2.7	3.7
6	3.5	4.4
10	4.4	5.5
16	5.3	7
25	6.9	8.9
35	8.2	10
50	10	12
70	12	14

Lexic modular distribution blocks for totally "universal" use >

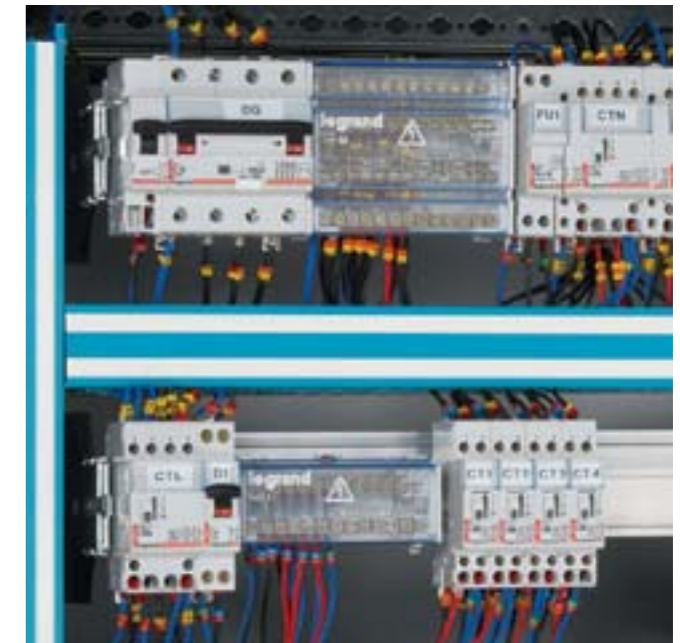

# Distribution blocks (continued)

## PHASE BALANCING

A well-designed installation should never require rebalancing after it has been built. However, there are always unforeseen circumstances:

- The loads may not have been correctly identified (uses on power sockets)
- The loads may be irregular, or even random: holiday homes, office blocks, etc.

Three-phase loads connected with motive power, heating, air conditioning, furnaces and in general any uses with a direct three-phase supply do not generate any significant unbalance.

However, all household applications (lighting, heating, domestic appliances) and office applications (computers, coffee machines, etc.) represent single phase loads that must be balanced.

Row of single phase outputs supplied via a DPX 125 (100 A)



Phase 1 supplies: 2 DX 32 A, 2 DX 20 A, 1 DX 10 A  
 Phase 2 supplies: 1 DX 32 A, 2 DX 20 A, 3 DX 10 A  
 Phase 3 supplies: 1 DX 32 A, 3 DX 20 A, 1 DX 10 A



The neutral conductor must be the same cross-section as the phase conductors:

- In single phase circuits, regardless of the cross-section, and in polyphase circuits up to a phase conductor cross-section of 16 mm<sup>2</sup> for copper (25 mm<sup>2</sup> for aluminium)
- Above this, its cross-section can be reduced in line with the load, unbalance, short-circuit thermal stress and harmonic conditions (see Book 4: "Sizing conductors and selecting protection devices").



### Breaking of the neutral

If the neutral breaks (maximum unbalance), the neutral point moves according to the load of each phase. The greater the load on a phase (phase 1 in this diagram), the lower its impedance.  $V_1$  drops,  $V_2$  and  $V_3$  increase and may reach the value of the phase-to-phase voltage on the phases with the lowest loads, which generally supply the most sensitive devices.

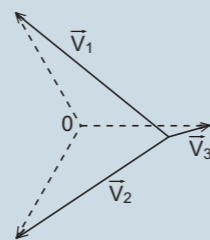

### Currents and voltages in star configuration three-phase system

#### In balanced system

$$Z_1 = Z_2 = Z_3$$

$$I_1 = I_2 = I_3$$

$$I_1 + I_2 + I_3 = 0$$

$$V_1 = V_2 = V_3 = V$$

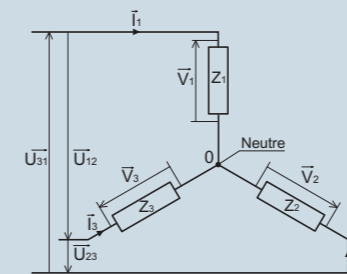

$$\vec{V}_1, \vec{V}_2, \vec{V}_3: \text{Phase-to-neutral voltages}$$

$$\vec{U}_{12}, \vec{U}_{23}, \vec{U}_{31}: \text{Phase-to-phase voltages}$$

$$U_{12} = V_1 - V_2$$

$$U_{23} = V_2 - V_3$$

$$U_{31} = V_3 - V_1$$

$$U = V \times \sqrt{3}$$

$$(400 = 230 \times \sqrt{3})$$

$$(230 = 127 \times \sqrt{3})$$

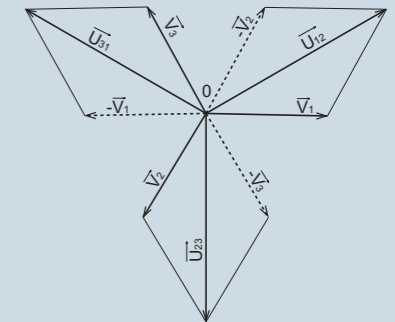

#### In unbalanced system with neutral

$$Z_1 \neq Z_2 \neq Z_3$$

$$I_1 \neq I_2 \neq I_3$$

$$I_1 + I_2 + I_3 = I_n$$

$$V_1 = V_2 = V_3 = V$$

The phase-to-neutral voltages remain balanced.

The neutral conductor maintains the balance of the phase-to-neutral voltages  $V$  by discharging the current due to the unbalance of the loads. It also discharges the current resulting from the presence of harmonics.

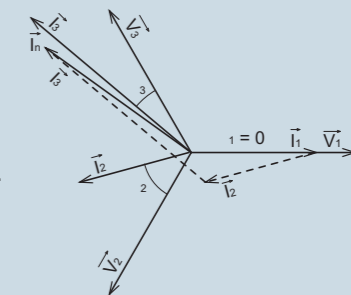

#### In unbalanced system without neutral

$$Z_1 \neq Z_2 \neq Z_3$$

$$I_1 \neq I_2 \neq I_3$$

$$I_1 + I_2 + I_3 = 0$$

$$V_1 \neq V_2 \neq V_3$$

The phase-to-neutral voltages  $V$  are unbalanced even though the phase-to-phase voltages  $U$  remain equal.

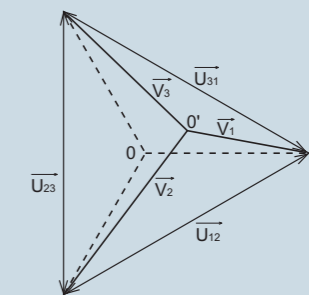



# Distribution blocks (continued)

**Currents and voltages in delta configuration three-phase system**

**Balanced delta configuration**

$Z_1 = Z_2 = Z_3$   
 $J_1 = J_2 = J_3$   
 $I_1 = I_2 = I_3 = 0$

**Unbalanced delta configuration**

$Z_1 = Z_2 = Z_3$   
 $J_1 = J_2 = J_3$   
 $I_1 = I_2 = I_3$  but  $I_1 \neq I_2 \neq I_3 = 0$

**J: phase-to-neutral current**  
**I: phase-to-phase current**

$I_1 = J_1 - J_3$   
 $I_2 = J_2 - J_1$   
 $I_3 = J_3 - J_2$   
 $I = J \times \sqrt{3}$

Unbalance does not have any consequences on the voltage in delta configurations, but the balance of the currents remains necessary to avoid line overcurrents (one phase overloaded) and limit inherent voltage drops.

In three-phase installations, the various circuits should be distributed on each phase, taking into account their power, their load factor (ratio of the actual power consumption to the nominal power), their operating factor (ratio of the operating time and the stoppage time to be weighted with the operating schedules) and their coincidence factor (ratio of the load of the circuits operating simultaneously to the maximum load of all of these circuits). See Book 2 "Power balance and choice of power supply solutions". Distribution optimises the energy management.

**The maximum number of lighting points or socket outlets supplied by one circuit is 8. Special or high power circuits (water heater, oven, washing machine) must be provided for this use only. The maximum number of heaters must be appropriate for continuity of service.**

**! Cable cross-sections and ratings of protection devices according to circuits**

230 V single phase circuit	Copper cross-section (mm <sup>2</sup> )	Fuse rating (A)	Circuit-breaker rating(A)
Signalling	0.75/1	2	6
Lighting	1.5	10	16
16 A power socket	8 max. 5 max.	16	20 16
Water heater	2.5	16	20
Washing machine/tumble dryer/oven, etc.	2.5	16	20
Cooking appliance	single phase three-phase	32 20	32 20
Electric heating	2250 W 4500 W	1.5 10	10 20

Care must be taken to maintain the minimum required cross-sections during balancing operations: each circuit must remain protected by the recommended device.

**+ Legrand electricity meters and measuring devices give the significant values of the installation at all times: current, voltage, actual power, power consumption, in order to optimise the load factor. Programmable time switches and programmers can be used to shift the operating ranges and "smooth out" consumption over time (operating factors).**

^ Modular central measuring unit

^ Flush-mounted central measuring unit

^ Electrical energy three-phase meter

^ Time switch



# Distribution blocks (continued)

## LEGRAND DISTRIBUTION BLOCKS

The following installation possibilities and characteristics that have previously been described: rated current, short-circuit resistance, insulation values, number and capacities of outputs, connection method, enable the most suitable choice of distribution block to be determined.

**+** The Legrand range of distribution blocks meets the needs of a wide variety of requirements, providing both ease of use and maximum safety.

Electrical characteristics of distribution blocks								
Type	Cat. Nos.	In (A)	I <sup>2</sup> t (A <sup>2</sup> s) <sup>(1)</sup>	I <sub>cw</sub> (kA)	I <sub>pk</sub> (kA)	U <sub>i</sub> (V)	U <sub>imp</sub> (kV)	
Unprotected terminal blocks	screw	048 01/03/05/06/07	63/100	1.2 10 <sup>7</sup>	3.5	17	400	8
	on support	048 20/22/24/25						
IP 2x terminal blocks screw terminals	green	048 30/32/34/35/36/38						
	blue	048 15/40/42/44/45/46/48						
	black	048 16/50/52/54						
Modular distribution blocks	one-piece	048 81/85	40	0.9 10 <sup>7</sup>	3	20	500	8
		048 80/84	100	2.0 10 <sup>7</sup>	4.5	20		
		048 82/88	125	2.0 10 <sup>7</sup>	4.5	18		
	can be joined	048 86	160	1.8 10 <sup>7</sup>	4.2	14.5		
		048 77	250	6.4 10 <sup>7</sup>	8	27		
		048 71	125	3.6 10 <sup>7</sup>	6	23		
		048 83	160	1.0 10 <sup>8</sup>	10	27		
Power distribution blocks for lugs	extra-flat	374 47	125	1.1 10 <sup>7</sup>	4.1	25	500	8
	stepped	374 00	250	3.2 10 <sup>8</sup>	8/12 <sup>(2)</sup>	60	1000	12
373 95		125	1.7 10 <sup>7</sup>	4.1	20	600	-	
374 30		125	7.4 10 <sup>7</sup>	8.5	35	1000	12	
374 31		160	1.0 10 <sup>8</sup>	10	35			
374 35		250	2.1 10 <sup>8</sup>	14.3	35			
Aluminium/copper connection boxes	373 08	400	3.4 10 <sup>8</sup>	17	50/75 <sup>(3)</sup>	-	10	
	374 80	300	2.1 10 <sup>8</sup>	14.5	> 60	-	10	
	374 81	400	4.9 10 <sup>8</sup>	22.2	> 60	-	12	

(1) The thermal stress limited by the upstream device must be less than the I<sup>2</sup>t of the distribution block, and the thermal stress limited by the downstream device must be less than the I<sup>2</sup>t of the cable: if necessary adapt the cross-section of the cable.

(2) Upper/lower ranges - (3) Spacing between 50 mm/60 mm bars

### Thermal stress permitted by conductors with PVC insulation

S (mm <sup>2</sup> )	1.5	2.5	4	6	10	16	25	35	50	70	95
Copper	I <sup>2</sup> t (A <sup>2</sup> S)	0.3 x 10 <sup>5</sup>	0.8 x 10 <sup>5</sup>	0.2 x 10 <sup>6</sup>	0.5 x 10 <sup>6</sup>	1.3 x 10 <sup>6</sup>	3.4 x 10 <sup>6</sup>	8.3 x 10 <sup>6</sup>	1.6 x 10 <sup>7</sup>	3.3 x 10 <sup>7</sup>	6.4 x 10 <sup>7</sup>
	I <sub>cw</sub> (kA)	0.17	0.29	0.46	0.69	1.15	1.84	2.9	4	5.7	8
Alumin.	I <sup>2</sup> t (A <sup>2</sup> S)					5.7 x 10 <sup>5</sup>	1.5 x 10 <sup>6</sup>	3.6 x 10 <sup>6</sup>	7 x 10 <sup>6</sup>	1.4 x 10 <sup>7</sup>	2.8 x 10 <sup>7</sup>
	I <sub>cw</sub> (kA)					0.76	1.2	1.9	2.7	3.8	5.3

## 1 INDEPENDENT DISTRIBUTION TERMINAL BLOCKS

Totally universal in their application, this type of terminal block can be used to distribute up to 100 A on between 4 and 33 outputs, depending on the catalogue number. The incoming cross-section is between 4 and 25 mm<sup>2</sup>, and the outputs between 4 and 16 mm<sup>2</sup>. They are fixed on 12 x 2 flat bars or TH 35-15 and TH 35-7.5 rails.

### Independent distribution terminal blocks



^ Unprotected terminal blocks on supports are generally fixed on 12 x 2 flat bars for connecting protective conductors

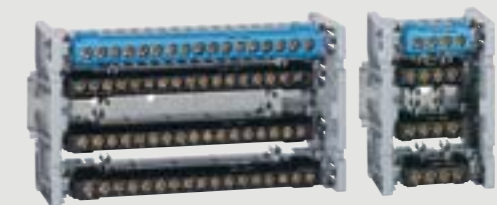

^ Combining IP 2x terminal blocks and support Cat. No. 048 10 enables a 2P, 3P or 4P distribution block to be created

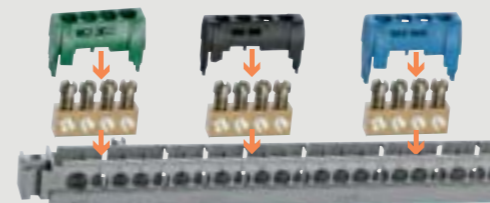

^ Empty support for terminal blocks enables exactly the right number of connections to be created

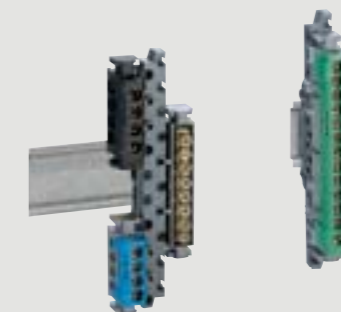

< Fixed on or rail, the universal support Cat. No. 048 11 takes all terminal blocks

# Distribution blocks (continued)

## 2 LEXIC SUPPLY BUSBARS

Supply busbars can be connected directly and supply power to Lexic modular devices up to 90 A. They are available in single, two, three and four pole versions. They are a flexible solution, taking up little space, and are easy to adapt for distribution in rows.





^ Distribution via four pole supply busbar Cat. No. 049 54 fitted with end protectors Cat. No. 049 91



^ Supply busbar supplied via universal terminal Cat. No. 049 06

+

^ A space is made in the devices that do not need to be connected to the supply busbar

^ Total combination of functions using the Lexic concept. Power, control and signalling are grouped together in wiring areas corresponding to the physical areas of the installation

## 3 DISTRIBUTION TERMINALS

These single pole distribution blocks are fixed directly in the terminals of DPX 125, 160 and 250 ER devices and modular Vistop devices from 63 to 160 A. They are used for simplified distribution for panels where the number of main circuits is limited.



^ Six 35 mm<sup>2</sup> rigid outputs (25 mm<sup>2</sup> flexible) for the output terminal Cat. No. 048 67



^ Single pole modular profile distribution blocks, total insulation of the poles to distribute 125 to 250 A

## 4 MODULAR DISTRIBUTION BLOCKS

These combine compactness and high connection capacity. With a modular profile, they are fixed by clipping onto TH 35-15 rails (EN 50022). Legrand modular distribution blocks are totally isolated: they are used at the supply end of the panel up to 250 A or in subgroups of outputs in panels with higher power ratings.



^ Totally universal, distribution blocks are suitable for all types of application



^ For the supply end of medium power distribution panels, the 250 A modular distribution block Cat. No. 048 77 can also be fixed on a plate



# Distribution blocks (continued)

## 5 EXTRA-FLAT DISTRIBUTION BLOCKS

Their lower height and their current-carrying capacities mean that the same panel can manage the power requirements for the supply end (up to 250 A) combined with the compactness of modular rows in slim panels.



< 250 A distribution blocks  
Cat. No. 374 35



< The key features of extra-flat distribution blocks are power, capacity to connect large cross-section cables and compactness.

## 6 STEPPED DISTRIBUTION BLOCKS

These are available in catalogue versions, complete and fully-assembled from 125 to 400 A, and in a modular version (bars and supports to be ordered separately) that can be used to create customised distribution.



^ 400 A stepped distribution block



< 125 A stepped distribution block

## 7 SINGLE POLE ALUMINIUM/COPPER CONNECTION BOXES

Designed to provide the interface between large cross-section conductors entering the panel, including those made of aluminium, and internal wiring conductors.

Two models 120 mm<sup>2</sup>/70 mm<sup>2</sup> (Cat. No. 374 80) and 300 mm<sup>2</sup>/185 mm<sup>2</sup> (Cat. No. 374 81) are available. They can also be used for aluminium operating circuits (outgoing cables) or when the line lengths require the use of large cross-sections.

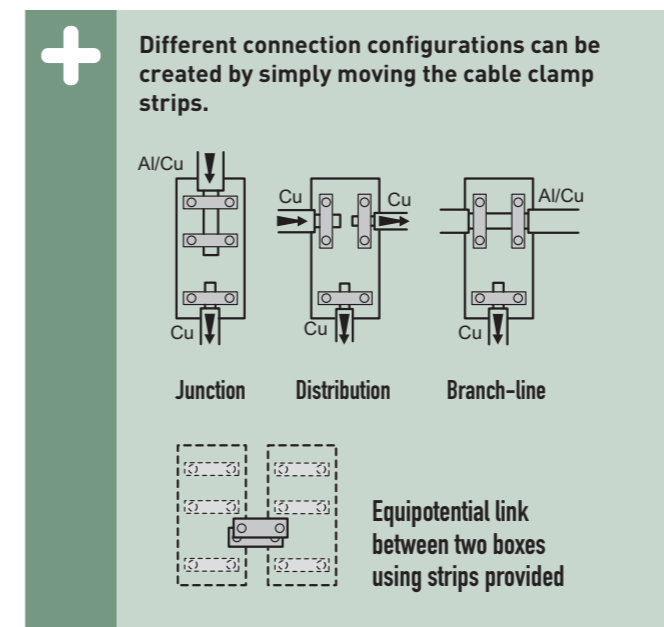

## 8 VIKING™3 POWER TERMINAL BLOCKS

These single pole blocks are used for the junction between the enclosure and the external cables. They are fixed on a rail or a plate and take CAB 3 and Duplix labelling. They provide numerous solutions for connection with aluminium or copper cables, with or without lugs.



< Alumin./copper direct connection

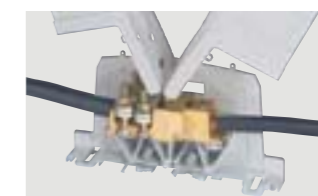

Cable/cable



Terminal for cable lug/ Terminal for cable lug



Terminal for cable lug/Cable



Cable/ Terminal for cable lug

→ All Viking™3 terminal blocks: see Book 11

# Choice of products

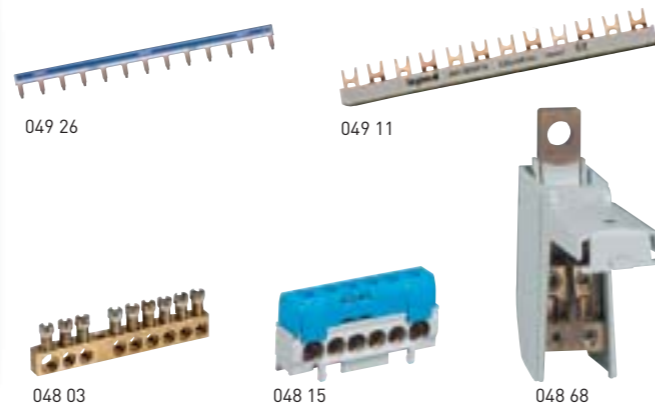

## Supply busbars from 63 to 90 A (Ipk 17 kÂ)

Type	Length	Universal 1-pole + neutral or 1-pole	2-pole	2-pole balanced on 3-phase	3-pole	4-pole
	meter	049 37	049 39	049 41	049 43	049 45
Fork-type	1 row	049 11	-	-	049 17	-
	meter	049 12	049 14	-	049 18	049 20

## Distribution terminal blocks from 63 to 100 A (Ipk 10 kÂ)

Number of outputs	Bare terminal blocks		Insulated terminal blocks IP 2x (xxB)		
	with screws	on support	black	blue	green
4	048 01	048 20	048 50	048 40	048 30
6			048 16	048 15	
8	048 03	048 22	048 52	048 42	048 32
12		048 24	048 54	048 44	048 34
14	048 05				
16		048 25		048 45	048 35
19	048 06			048 46	048 36
24	048 07	048 26			
33		048 28		048 48	048 38

## Modular distribution blocks from 40 to 250 A (Ipk 14.5 to 42 kÂ)

Admissible maximum rating (A)	2-pole			4-pole			Terminal blocks IP 2x		
	Cat. Nos	Number and section of flexible conductors (mm²)		Cat. Nos	Number and section of flexible conductors (mm²)		Earth	Neutral	Additional outputs (mm²)
		Inputs	Outputs		Inputs	Outputs			
40	048 81	2 x 10	11 x 4	048 85	2 x 10	11 x 4	048 34	048 44	12 x 6
100	048 80	2 x 16	5 x 10	048 84	2 x 16	5 x 10	048 32	048 42	8 x 6
125	048 82	2 x 25	2 x 16 + 11 x 10	048 86	2 x 25	2 x 16 + 7 x 10		048 44	12 x 6
				048 88	2 x 25	2 x 25 + 11 x 10	048 35	048 45	16 x 6
				048 76	1 x 35	1 x 25 + 1 x 16 + 14 x 10		048 46	21 x 6
160				048 79	1 x 70	2 x 25 + 4 x 16 + 8 x 10		048 45	16 x 6
250				048 77	1 x 120	1 x 35 + 2 x 25 + 2 x 16 + 6 x 10			

## Single pole modular distribution blocks and distribution terminal from 125 to 250 A (Ipk 27 to 60 kÂ)

	Admissible maximum rating (A)	Cat. Nos	Number and section of conductor per pole (mm²)	
			Inputs	Outputs
modular distribution blocks	125	048 71	4 x 35	12 x 10
	160	048 83	1 x 50	3 x 25 + 2 x 16 + 7 x 10
	250	048 73	1 x 120	6 x 25 + 4 x 10
distribution terminal	160	048 67	Direct into downstream terminal	6 x 25
	250	048 68	Direct into downstream terminal	4 x 35 + 2 x 25

## Power distribution blocks from 125 to 400 A (Ipk 20 to 75 kÂ)

Admissible maximum rating (A)	Extra-flat			Stepped		
	Cat. Nos	Number and section of conductor per pole (mm²)		Cat. Nos	Number and section of conductor per pole (mm²)	
		Inputs	Outputs		Inputs	Outputs
125	374 47	1 x 35	10 x 16 (Ph) 17 x 16 (N)	373 95	4 bars 12 x 4 mm receiving 5 connectors 2 x 10 each	
				374 30	1 x 35	5 x 25
160				374 31	1 x 70	5 x 35
250	374 00	1 x 150	1 x 70 or 1 x 50 + 1 x 35 or 2 x 35	374 35	1 x 120	5 x 50
400				373 08	2 x 8.5 mm	21 holes M6 70 mm² max. connectors
				374 42	2 x 185	15 holes M6 + 15 holes M8

## Aluminium/copper distribution boxes

Admissible maximum rating (A)	Cat. Nos	Number and section of conductor per pole (mm²)		
		Input aluminium	Input copper	Output copper
300	374 80	1 x 120	1 x 95	1 x 70
540	374 81	1 x 300	1 x 150	1 x 150





373 24



373 10



373 66

### Isolating supports and copper bars

Busbar supports		I Admissible maximum rating (A)							
		125	160	250	400	800	1000	1600	4000
Universal supports	1-pole	373 98		374 37					
	4-pole	373 96	374 32		374 36	373 10			
XL <sup>3</sup> supports	4-pole					373 15	373 20	373 21	373 22/23 373 24/25
Maximum number of bars per pole									
Copper bars	12 x 2	373 88	1						
	12 x 4	373 89	1	1					
	15 x 4	374 33			1				
	18 x 4	374 34		1	1	1	1		
	25 x 4	374 38			1	1			
	25 x 5	374 18					1	1	
	32 x 5	374 19					1	1	
	50 x 5	374 40						1	1
	63 x 5	374 41						1	2
	75 x 5	374 59						1	2
	80 x 5	374 43						1	2
	100 x 5	374 46							2
	125 x 5	-							
	50 x 10	-							
	60 x 10	-							
80 x 10	-								
100 x 10	-								
125 x 10	-								

### Isolating supports for C-section busbars and aluminium bars (up-to 1600 A)

Isolating support	Enclosure depth (mm)	Bars aligned	Bars staggered
		475 or 725	373 66
	975	373 68	373 69
Aluminium C-section bars	Cross section (mm <sup>2</sup> )	Cat.Nos	
	524	373 54	
	549	373 55	
	586	373 56	
	686	373 57	
	824	373 58	

## POWER GUIDE: A complete set of technical documentation



01 | Sustainable development



08 | Protection against external disturbances



02 | Power balance and choice of power supply solutions



09 | Operating functions



03 | Electrical energy supply



10 | Enclosures and assembly certification



04 | Sizing conductors and selecting protection devices

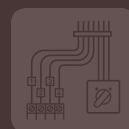

11 | Cabling components and control auxiliaries



05 | Breaking and protection devices

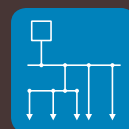

12 | Busbars and distribution



06 | Electrical hazards and protecting people



13 | Transport and distribution inside an installation



07 | Protection against lightning effects



Annexes  
Glossary  
Lexicon



**World Headquarters and International Department**  
87045 Limoges Cedex - France  
☎ : + 33 (0) 5 55 06 87 87  
Fax : + 33 (0) 5 55 06 74 55